



CUSTOMER MAGAZINE

Joint Success 2015

When ideas bear fruit...

Successful Projects, News, Events
and much more



HellermannTyton

FESTO

MONTECH



PHILIPPGRUPPE

OECHSLER

GEBERIT

HepcoMotion®
ADVANCED LINEAR SOLUTIONS

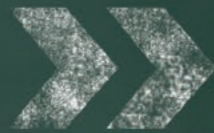

To achieve excellence,
copying is not enough

CADENAS - The Innovation Company



CADENAS
THE INNOVATION COMPANY

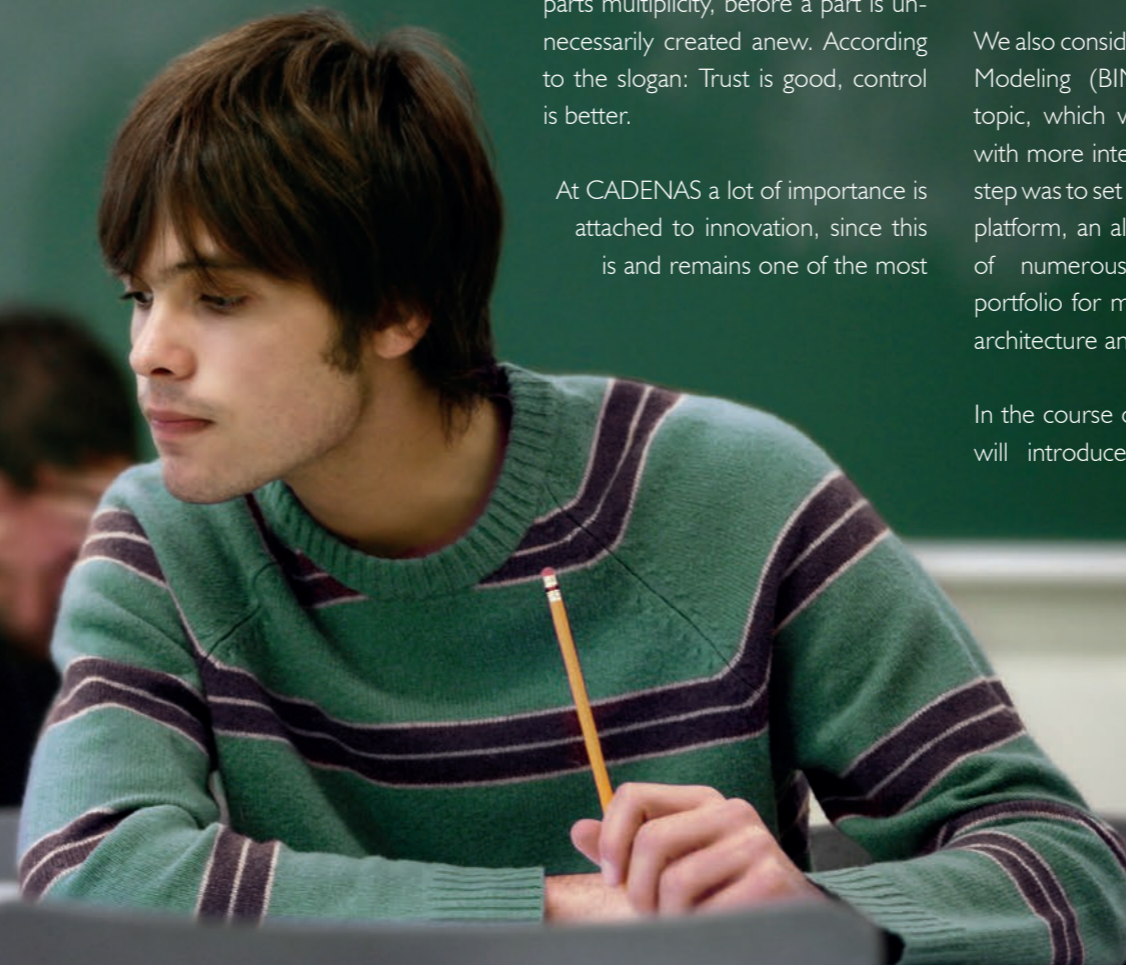

Editorial

This was the year 2015!

Dear customers and partners,

in more than 20 years of CADENAS history many have tried to copy us, because until today we have a pioneering role in development. We think it is not enough just to copy others to achieve top performance.

Even today we don't get tired of developing new, revolutionary ideas and realizing them.

The integrated PURCHINEERING 2.0 concept of our Strategic Parts Management PARTsolutions is, for instance, very suitable to pull purchasing and engineering together. Now the company can act and curb parts multiplicity, before a part is unnecessarily created anew. According to the slogan: Trust is good, control is better.

At CADENAS a lot of importance is attached to innovation, since this is and remains one of the most

important success factors – for us as well as our customers.

We are not running out of ideas for PARTsolutions, as many features and methods can be further improved. In the course of the coming year we will present further possibilities, one of them will be Classification 2.0.

Also eCATALOGsolutions is becoming increasingly sophisticated: with the new Smart Sales feature, where manufacturers know who and where their customers are. With the suitable products, the component manufacturer will be at the right place at the right time. This supports sales, optimizes the sales force and makes it possible to recognize sales potential before the competitors.

We also consider Building Information Modeling (BIM) as a trendsetting topic, which we would like to deal with more intensely next year. A first step was to set up the BIMcatalogs.net platform, an all-encompassing library of numerous BIM objects and portfolio for manufacturers from the architecture and building industry.

In the course of the coming year we will introduce further innovations.

You can get detailed information about the planned innovations in advance at our annual Industry-Forum taking place on 8th and 9th March 2016.

We would like to thank our customers and partners for the successful cooperation and together we will start with new innovations into a promising 2016.



CADENAS – The Innovation Company
Yours sincerely

Jürgen Heimbach
Dipl.-Ing. (FH)
Managing Director
CADENAS GmbH



Common

- [3](#) Editorial
- [4](#) Table of Contents
- [6](#) The CADENAS year 2015
- [14](#) Worldwide Success

PARTsolutions

- [18](#) SNCF success story
- [20](#) IMAFORNI success story
- [22](#) PARTsolutions version 10
- [27](#) ARES Commander, CorelCAD and DraftSight plugin
- [28](#) Strategic Parts Management goes mobile
- [30](#) New PARTcloud.net version online
- [32](#) Social media for engineers
- [36](#) OECHSLER AG
- [38](#) Geberit Group
- [39](#) Software Tool4Search

eCATALOGsolutions

- [40](#) PARTcommunity version 5.0
- [42](#) Optimisation for mobile devices
- [43](#) PARTcommunity downloads 2015
- [44](#) HellermannTyton product catalog
- [46](#) Montech success story
- [48](#) AVENTICS product catalog
- [50](#) HepcoMotion
- [51](#) Festo Design Tool 3D
- [52](#) PHILIPP group & BIM catalogs
- [54](#) SOUCHIER – 2D & 3D BIM CAD product configurator
- [56](#) AZOLGAS-NITROCYL product catalog
- [57](#) Integration of a CAD model as an iframe into the news
- [58](#) Social app WeChat

The CADENAS year 2015

New branch office in Bristol



Since the beginning of December 2014, CADENAS is represented with their own subsidiary within the United Kingdom.

"My aim is to offer customers high-quality software solutions and thus establish CADENAS Solutions UK as an important partner for companies of the mechanical, plant, and electrical engineering sector in the UK and Ireland", says Colin Johnson, Managing Director.



New branch office in Turkey



CADENAS established a new branch office on the Bosphorus on the 1st April 2015.

Akin Terzi advises and supports existing and prospective customers in Turkey locally and in their language. His target is to make CADENAS software solutions popular in the region and establish the company as an important partner in the market. "In the long term it is my goal to build a strong and successful bridge between engineers and manufacturers", says Akin Terzi.

Trade fair entertainment at the HMI

CADENAS' trade fair entertainment turned the exhibition stands of the partners AVENTICS and Diplomatic Oleodinamica to a real magnet for visitors: by using Microsoft Kinect and the Dreamoc™ holographic display, the 3D CAD models of the component manufacturers became eye-catchers, attracting numerous visitors at the Hanover fair.

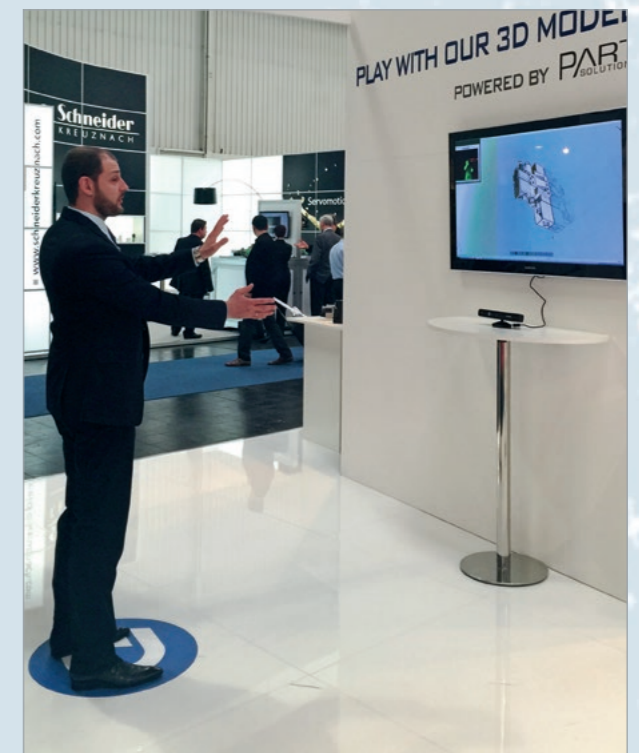

CADENAS Solutions Forum Italiana

In May CADENAS organized the exclusive Solutions Forum for the sixth time, which took place at the Calzavecchio Hotel in Bologna. More than 60 participants from the mechanical and plant engineering sector as well as from general engineering were able to find out more in numerous presentations on-site, about trends in the area of strategic parts management and electronic product catalogs.

Siemens PLM Connection Greater China User Conference

At the beginning of March, CADENAS China Ltd. successfully presented the software solutions of CADENAS at the Siemens PLM Connection Greater China User Conference in Nanjing.



CADENAS Summer Festival

The CADENAS summer festival of the year was the perfect event for the hot July: at the public pool Fribbe in Augsburg, two beach volleyball courts invited the employees of CADENAS to an exciting tournament.



The year's winning team enjoying a champagne shower on the winner's rostrum.



Taking a little break with a cold drink or a refreshing swim in the Eiskanal.



Industry-Forum

At the 16 Industry-Forum in February, around 200 participants from the mechanical, plant and electrical engineering sector were informed in 20 best practice presentations about innovations and trends regarding the topic of cost reduction with the strategic parts management and expanding marketing possibilities with electronic CAD product catalogs

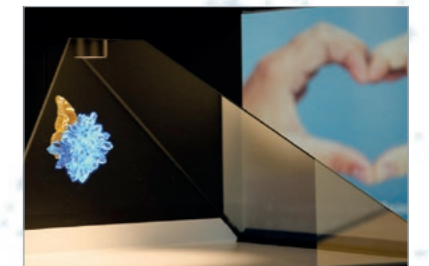
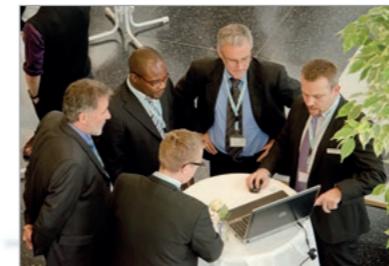

During the traditional evening event, the participants were able to score strikes: the 24 bowling lanes offered the ideal sporting balance to the informative conference day and numerous possibilities to share with other participants in an informal atmosphere.



Engineering Newcomer

At the Motek in Stuttgart an expert jury announced the winners of the Engineering Newcomer Challenge 2015 in October. This competition gave pupils and students the chance to hand in a final year project in the field of engineering and development they had worked on in the course of their traineeship or studies. They were not only motivated by attractive prize money, but also by generating a lot of attention for their project. "Young talents have become increasingly rare. Therefore it is important to us, to promote them with this competition", says jury member Marcus Schneck, CEO of norelem in Stuttgart.

"An important aspect of CADENAS' development has always been to work together with young people. Together with them, we analyze fresh and new ideas and thus we ourselves get input for our product development", says Jürgen Heimbach, CEO of the software manufacturer CADENAS and also a member of the jury. "This is why we called this annual competition into life together with norelem, to recognize trends at an early stage."

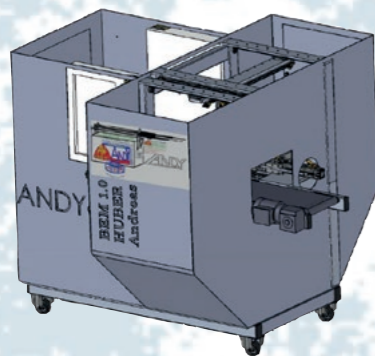

1. Platz

The 15-year old students Andreas Huber and Albin Wolfersberger, from the HTBLuVA Salzburg, were winners with their design of a machine to wrap up cutlery. It can make small packages of forks, knives and napkins.



2. Platz

Philipp Werner and Daniel Kröner from the Grundig Academy handed in their project "Exploration robot ExHum". They documented the development, design and manufacturing of the remote controlled explorer robot with a gripper and a camera.



3. Platz

Bastian Wanger, Julia Löbl and Paul Krecu from the technical college Allgäu in Kempten convinced the jury with the design project "Aqua-scooter", which was part of their 2-year training to become engineering technicians.

German Standard Part Award 2015

The winners of the German Standard Part Award were chosen at the Motek in Stuttgart in October 2015. CADENAS and Otto Ganter awarded the best and most efficient contributions with the most standard parts.



1. Platz

Jürgen Gnörich of HAWEKA AG from the team realizing the impossible, convinced the jury with a consequent use of standard parts in his design of the Airgo Lift. A lifter, which supports wheel centering at the balancing machine while at the same time saving the back. It can be operated with one hand, thus also offers great flexibility.

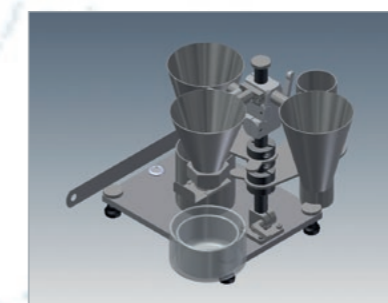

2. Platz

Stefan Uhlmann of the Technical University in Chemnitz, applied with a test device to determine the bulk density and pourability of granulates. The device, made of several standard parts, excels by combining the functionality of three or four single devices and is also very easy to exchange individual components.

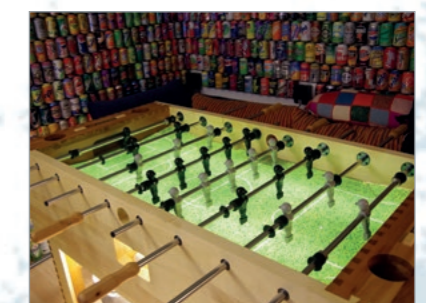

3. Platz

Andreas Wolpert used standard parts several times in his individual table football game. With different features, like a body made of solid wood with open and closed zinc compounds, the illuminated playing field made of glass, an integrated cup holder, the table football from Wolperts differs greatly from current models on the market.



Motek 2015

CADENAS, as co-exhibitor, supported the Afag Automation AG with the presentation of new products at the Motek in Stuttgart from 6th to 8th October 2015. With the trade fair entertainment package, CADENAS perfectly drew the attention of the visitors to the components .

The program extension for the electric gripper or the new CR-D-modules with combined air and electro circulation systems were, for instance, presented with the Dreamoc™ Holographic display.



In the display, the 3D CAD models of the electronic product catalog can be depicted with a laser. By using modern technology, the Afag components were real eye-catchers, astonishing many visitors. As floating 3D animations products, like the virtual master shaft, were shown in an outstanding way, with the modern presentation technology.

eCATALOGsolutions Day in Istanbul

The Turkish establishment of CADENAS organized the first eCATALOGsolutions day at the Elite World Hotel in Taksim, Istanbul on the 15th of October 2015.

The participants were informed about innovations and trends regarding electronic product catalogs based on eCATALOGsolutions Technology.



New office rooms for CADENAS in Esslingen

The CADENAS subsidiary in Esslingen moved to new premises in October 2015. To offer the best customer service also in the future, the new office space is spacious and furnished in a modern style. The meeting room also offers a lot of space and as of now, meetings in a large gathering are also possible.

Chasing Shadows

The students Michael, Sebastian and Lucas from the Jakob-Fugger Gymnasium in Augsburg, developed a miniature formula 1 racing car for the "F1 in schools" competition. Since CADENAS always finds it very important to promote young people, it almost went without saying to participate in the student project. Besides a financial contribution, the students were provided with a DREAMOC™ display and they used PARTcloud to convert the models of their racing car into 3D objects.



Worldwide Success 2015

China | CADENAS China Ltd.

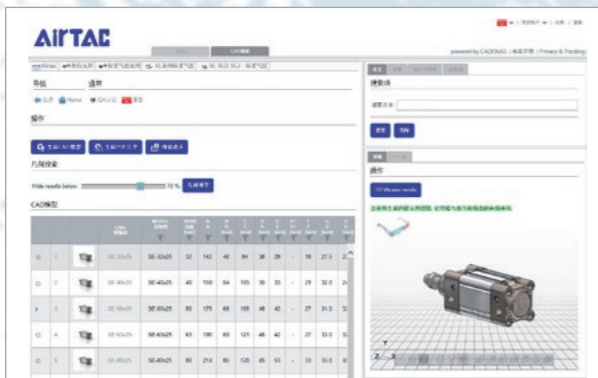

» <http://en2.airtac.com/>

AirTAC Group

AirTAC AirTAC group is one of biggest supplier of pneumatic components in China, it is placed after FESTO and SMC.

Since 2009 AirTAC has used eCATALOGsolutions to update the 3D CAD catalog, the marketing director Mr Xu said "AirTAC provides not only the best products, but also with help of eCATALOGsolutions we can provide our customers the best pre- or after service, too! After releasing the offline CD is delivered over 10,000 copies in only 2 weeks, it is really gotten market recognition."

Turkey | CADENAS Yazılım Hizmetleri Türkiye



» www.alternatifyayincilik.com

Alternatif Verlag

alternatif yayın grubu In cooperation with CADENAS, the publishing house Alternatif offers its 24,000 readers 3D Cad models of renowned manufacturers for free download on its website. The product catalogs were directly integrated into the publisher's website with CADENAS' PARTcommunity embedded technology.

France | CADENAS France SARL

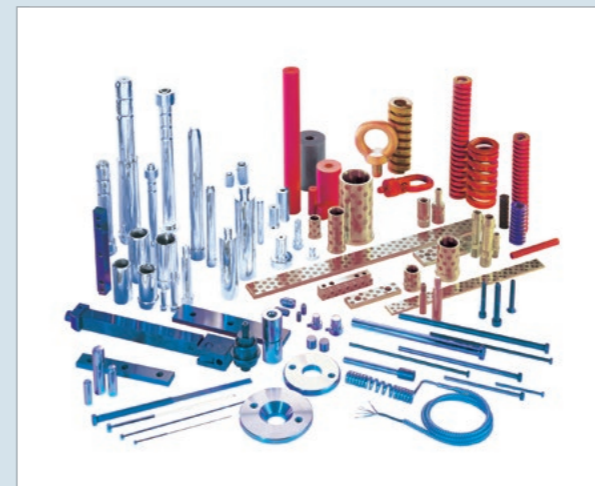

» www.rabourdin.fr

RABOURDIN SAS

RABOURDIN The French leading manufacturer of mold and die parts offers 3D CAD models of its products on CADENAS download portals. The 3D CAD models of Rabourdin's parts (components for ejection, centering, guiding as well as fastening) are now available to toolmakers and mold makers. They can download the parts form following websites:

- www.rabourdin.fr
- <https://rabourdin.partcommunity.com>.

Japan | CADENAS WEB2CAD INC.



» www.toyo-seikan.co.jp

Toyo Seikan

TOYO SEIKAN GROUP Toyo Seikan is a leading company in the production of PET bottles, cans, plastic and metal packaging containers. One of the key factors in supplying high-performance, high-quality packaging containers is the use of their own production facilities. Due to the use of numerous commercially available parts and the need to rapidly obtain accurate 3D CAD data, it was important to reduce the man-hour design cost while keeping optimal operation of the 3D design process. As a response to these concerns, Toyo Seikan chose CADENAS PARTsolutions as a high-quality commercial component library.

 Italy | CADENAS Italiana S.r.l.

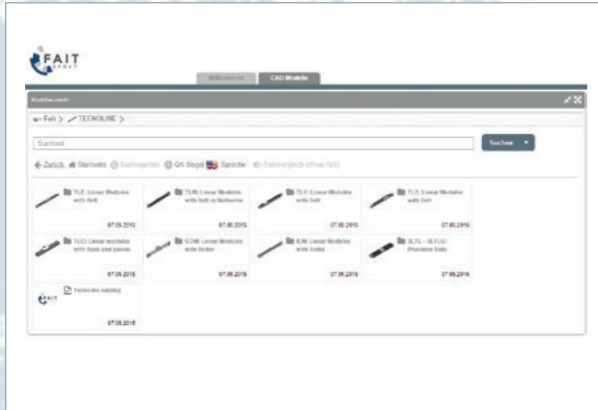

» <https://fait.partcommunity.com>

Fait Group SPA



Through eCATALOGsolutions technology from CADENAS Fait Group offers direct access to its product catalog. This includes catalogs for product families TecnoLine, Moduline and Texroll. It is also possible to view and export the technical data sheet of the different components in PDF format. Fait Group is an Italian company specialized in production and distribution of components and systems for linear and rotary motion as well as power transmission.

ARI metal



ARI metal offers a new service to customers: the possibility to download the complete catalog with technical drawings of all products, in both 3D and 2D formats, directly from CADENAS' PARTcommunity. For more than twenty years ARI metal has been specialized in the development of the modular structural system "ALUMINUM PROFILE SYSTEM®", based on modular anodized aluminum profiles, which are very flexible for mechanical structures, economical in their applications and ready-to-use.

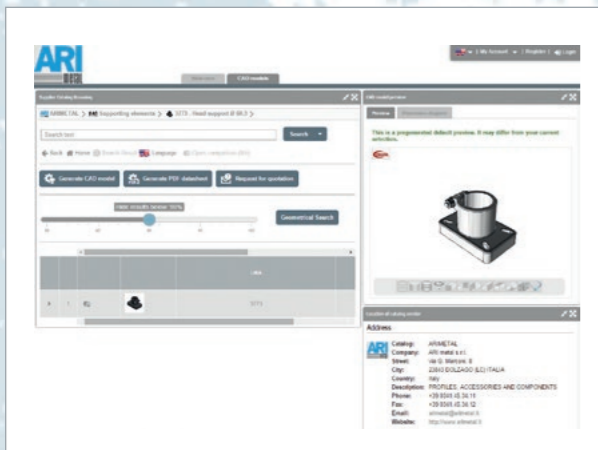

» <https://arimetal.partcommunity.com>

Fameccanica.Data SpA



CADENAS Strategic Parts Management PARTsolutions is used in the Italian company Fameccanica.Data S.p.A. in the field of design and assembly as well as procurement. About 20 employees use the Geometric Similarity Search (GEOserach) there for their daily work. Due to an automatic analyzing procedure carried out daily, parts diversity is reduced and duplicate copies are avoided.



» www.fameccanica.com

 USA | CADENAS PARTsolutions LLC

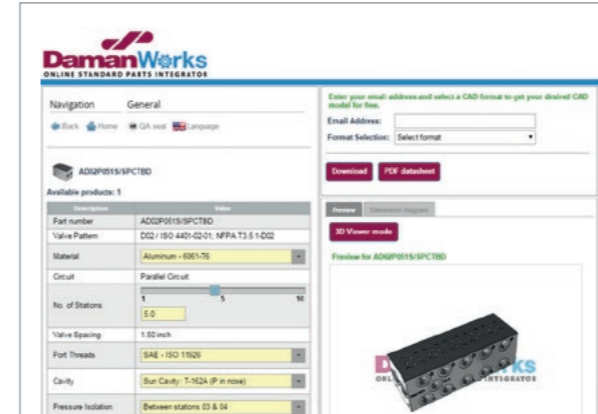

» www.daman.com/part-configurator-test

Daman Products Company, Inc.



Daman Products, a leading designer and manufacturer of hydraulic valve manifolds and related products, has announced the launch of their all new online configurator built by CADENAS. The self-serve interface enables Daman customers to configure the product they need, and instantly generate a 3D CAD model for use within their design. This on-demand approach is a competitive advantage for Daman Products, who is constantly improving customer service with an industry leading digital customer experience.

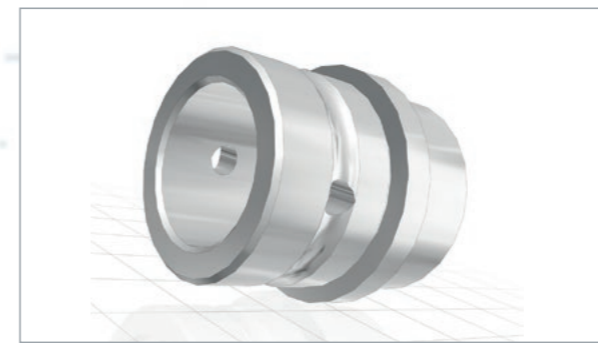

» www.choicemold.com

Choice Mold Components Inc.



Choice Mold Components, a Michigan based manufacturer of precision mold ready tooling, is redefining and expanding their digital customer experience. With the help of CADENAS, Choice Mold Components is strengthening their online presence with a new interactive product selector on www.choicemold.com, enabling users to configure and generate 2D and 3D CAD files during their design process.

Bishop Wisecarver Group (BWC)



Bishop Wisecarver (BWC), a leader in linear and rotary motion components has launched an all-new digital product catalog, built by CADENAS. The catalog, which can be found at www.bwc.com was the result of numerous customer requests for models in a wider variety of native CAD formats. In addition to meeting customer demands, the BWC digital product catalog will serve as a primary driver of marketing data with a direct integration to their Pardot marketing automation software.

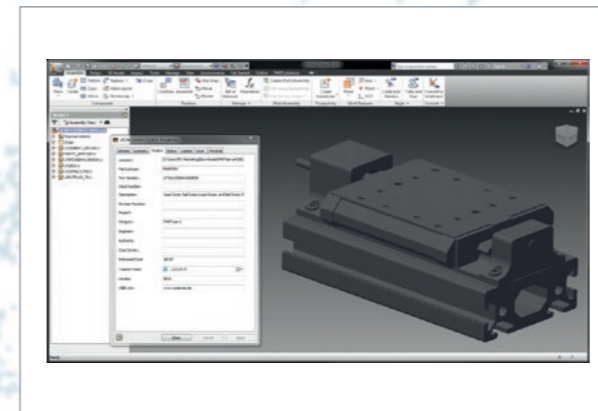

» www.bwc.com



Strategic Parts Management at SNCF: Multiplicity of bolted connection fasteners reduced by 15%

More than 10,000 parts were scrutinized

Since October 2013 the French railway company SNCF has been using CADENAS' Strategic Parts Management PARTsolutions in connection with their RNAS database.

With 700 users in train maintenance centers, engineering, procurement and logistics all over France, SNCF has been centralizing parts for rolling devices in a single parts database called RNAS for a long time.

This database has grown tremendously due to the addition of components by designers. Many duplicates appeared and the number of suppliers increased, thus consequently reducing the effectiveness of the purchasing department. The bolted connections committee therefore decided to implement a solution to standardize and regulate the fasteners. "We focused on fasteners as this is the category for

which we have the most numerous items in the database, that is to say the parts we need the most to be standardized and streamlined," explains Jérôme Mercier, project manager at SNCF. SNCF chose the Strategic Parts Management PARTsolutions by CADENAS to consolidate and standardize the fasteners used for bolted connections on all of its maintenance centers.

More efficiency with PARTsolutions

October 2013
Implementation of the information platform PARTsolutions at SNCF

10,000
Components were checked for duplicate copies

15%
Reduction of parts in only one year

More than 10,000 parts to streamline

The aim of the project is to limit the creation of new components in the parts database, to identify and eliminate duplicates and to encourage designers to reuse the fasteners defined as "standard" by the committee. As a first step the project focuses on the fasteners used for bolted

connections. More than 10,000 screws, nuts, washers and studs were scrutinized.

The objective of SNCF is to create a library with all relevant information for designers: SNCF's internal information (internal part number, technical documentation, materials, standardization level), official standard information (description, dimensions

etc.) and the 3D CAD models. After a successful test phase, the new information platform was implemented in October 2013 for all users working on rolling devices.

15% less bolted connection fasteners at SNCF

Starting with 10,000 parts, SNCF reduce the number of parts to 8,500 in only one year. A decrease of 15% that leads to savings in terms of procurement, storage and maintenance.

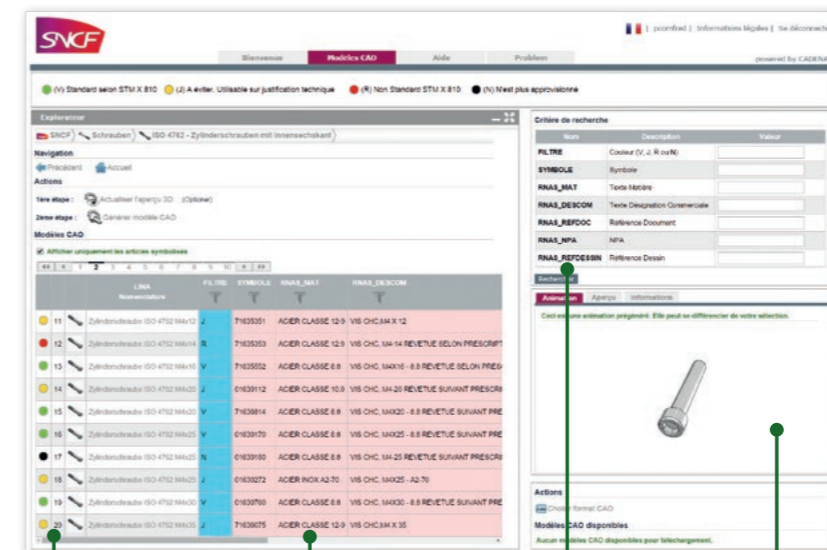

- Color code to see the part's release status at a glance**
- Information from SNCF internal RNAS database:**
 - internal part number
 - link to technical documentation
 - material, ...
- Search filters by:**
 - release status
 - part number
 - material, ...
- 3D preview of the part before downloading in CATIA V5 format**

The complete success story can be found at: www.cadenas.de/part-solutions/customers/success-stories#snfc



The Strategic Parts Management at IMAFORNI INT'L S.p.A

The Geometric Similarity Search as an effective tool for parts management

IMAFORNI in figures



Founded in **1962**



Today in **83** countries worldwide



More than **1,000** biscuit and cracker oven lines installed



120,000 standard and commercial parts



2012: implementation of the Geometric Similarity Search



50 working stations with PARTsolutions

One solution for all company departments

The Strategic Parts Management PARTsolutions by CADENAS met this requirement and it is now installed on approx. 50 work stations at IMAFORNI. "The search functions offered by CADENAS' software solutions are used in the technical, production and purchasing departments for 3D geometrical searching during the engineering phase and the geometrical comparison between similar parts or different releases of the same part number", says Venturelli. This is required to avoid the introduction of similar or duplicate part copies and improves the reuse of parts already released within the company.

The integration of the Strategic Parts Management PARTsolutions by CADENAS, with the existing PLM system used at IMAFORNI, was possible thanks to the implementation of processes which import parts during the night that have been released to the PLM system during the day. A check of all the parts verifies the presence of any duplicate copies within the imported components. This allows engineers to be offered alternatives for their possible use and also to avoid the creation of parts already existing in the database.

The benefits

One of the greatest benefits resulting from the installation of the Strategic Parts Management PARTsolutions at

ERP_PDM_NUMBER 3P-Number	CAOTYPE Tipo CAD	CODICE codice IM...	VERSIONE Versione	DESCRIZIONE Descrizione	* LASTVERSION Last Version	MATERIALE Materiale	RICAVATO_DA Ricarato da	SPECIFICA_TECNICA specifica tecnica	FAMIGLIA famiglia	DESCRIZIONE_AGG Descrizione Aggiuntiva
133	MD	P099130345	00	FLANGIA DI CHIUSURA	Ultima Revisione	ASSI 304				
134	MD	P099130347	00	FLANGIA	Ultima Revisione	Fe 37 C LINE 7070				
135	SW	P099130348	00		Ultima Revisione	SF61041018	SF61041018			
136	SW	P099130349	00		Ultima Revisione	SF61041016	SF61041016			
137	MD	P099130350	00	FLANGIA	Ultima Revisione	ASSI 304				
138	SW	P099130351	00		NONI Ultima Revisione	SF61041018	SF61041018			
139	SW	P099130351_01	01		NONI Ultima Revisione	SF61041018	SF61041018			
140	SW	P099130351_02	02	FLANGIA PER ATTACCO P480	Ultima Revisione	NERA DECAR. Fe 37 LINE 665	SF61041018			
141	MD	P099130352	00	FLANGIA PER UOP 211	Ultima Revisione	ASSI 304	SF01123080			TRABOGGIA CON ASPRO PER ALLENVAT
142	MD	P099130353	00	FLANGIA PER SUPPORTO	Ultima Revisione	ASSI 304	SF60400208			
143	MD	P099130354	00	FLANGIA PER RULLO	Ultima Revisione	ASSI 304	SF60400205			
144	MD	P099130358	00	FLANGIA	Ultima Revisione	ASSI 304	SF01123072			DE TENUTA

IMAFORNI is that "it is possible to optimize the management of the components already existing in the company system. Furthermore, the internal production and purchasing processes have been improved thanks to the Geometric Similarity Search GEOsearch, which has simplified the check procedure to verify the geometric differences between various versions of the parts", says Venturelli.

With reference to the possible parts reduction resulting from the implementation of the Strategic Parts Management PARTsolutions within the company, Venturelli explains that "it is difficult to verify this currently

because the typology of products have a high rate of personalization. Certainly during these months we have reused a lot of existing parts, avoiding the creation of new codes to handle."

An effective co-operation also for the future

In the near future, the co-operation between IMAFORNI and CADENAS will continue with the integration of the software solution PARTsolutions with the PLM system, to allow the management of the internal commercial codes and to support the activity of the Standardization department at IMAFORNI.

More information about the case study of IMAFORNI and CADENAS at: www.cadenas.de/partsolutions/customers/success-stories#imaforni



» The search functions offered by CADENAS' software solutions are used in the technical, production and purchasing departments for 3D geometrical searching during the engineering phase and the geometrical comparison between similar parts or different releases of the same part number. «

Valter Venturelli
Chief Information Officer
IMAFORNI INT'L S.p.A.





CADENAS performs a real
quantum leap with
PARTsolutions
version 10

Extended search features and an optimized user interface revolutionize strategic parts management for engineers and purchasers

With CADENAS new PARTsolutions version 10, a real quantum leap in the parts management sector was performed, which also revolutionizes the topic "Intelligent Finding" with many new features and improvements.

Engineers and purchasers are provided with significantly improved search features, helping them to find parts in their company and in the parts world without any hassle and in a targeted way. Moreover the intensive development efforts of the software manufacturer from Augsburg brought forth a multitude of impressive highlights. For instance the customized filter assistants, pioneering changes when classifying with the new solution Classification 2.0, display of all component dimensioning in a 3D window and numerous new interfaces to all common CAD-, PLM- und ERP systems.

Simplified use due to clearly arranged design

Due to the new user interface in the flat design, handling of CADENAS parts management is even more intuitive and efficient. This way new users of PARTsolutions can learn the handling simpler and faster. The extensive search feature window is now available in all views allowing a targeted access. Furthermore the search results are organized in clearly arranged multiple tabs. Thus the different search results are visible at any time, which makes the selection of the suitable part significantly easier. Moreover the complete layout in PARTsolutions can be adjusted individually according to the needs of the user.

Get quickly to the required component with the customized filter assistant

The new PARTsolutions version offers engineers a novelty: For the first time, filter assistants can be adjusted to the own requirements by

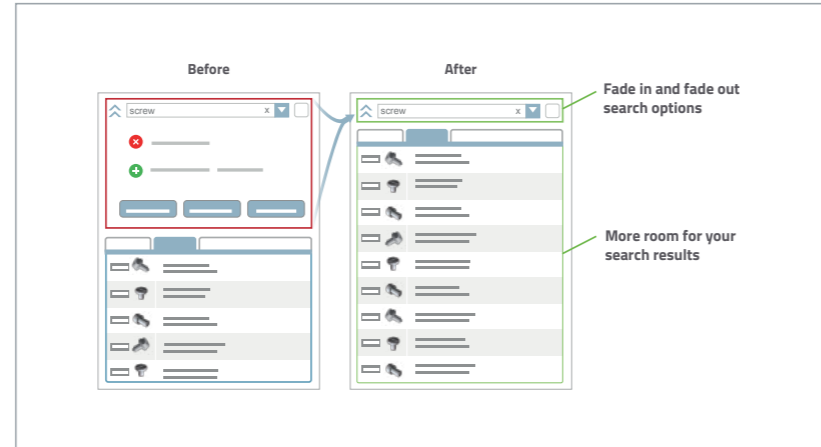

Compact user interface

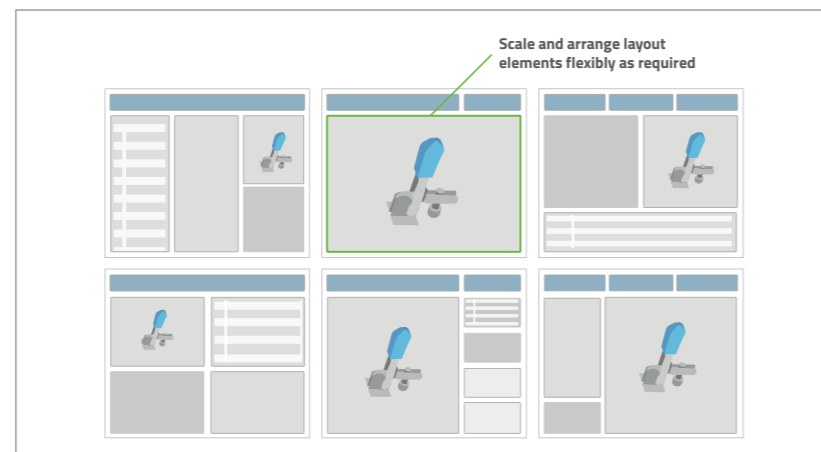

Individual layout



Cross-application search assistant

defining the respective filter variables for searching individually and determining the graphical interface. The customized filter assistants generated afterwards can be saved and provided to other users in the team or for

the Classification 2.0. Components that are frequently searched for can be found in an uncomplicated and effective way in manufacturing companies. An example for the practical use and success of the customized

filter assistants can be read in the mutual case study of the French railway company SNCF. By means of PARTsolutions the company was able to reduce the multiplicity of bolted connection fasteners by 15%.

All component information at a glance

Often engineers do not only need the dimensioning for 2D derivations but also in the 3D view. With the new PARTsolutions version 10, all component information is shown to the user in only one window. Thus it is no longer necessary to tediously switch back and forth between the different display windows. (Table, 2D dimensioning and 3D dimensioning). This way mistakes can be avoided and time for spent searching for components can be saved.

Partial 3D similarity search allows finding patterns or arrangements in components

Also the partial 3D similarity search, very popular among engineers, was further developed with the new version of the strategic parts management. Besides small part segments of a component also special geometric arrangements of other parts can be used for the partial 3D similarity search.

Innovative visualization creates clearly arranged search results

In the case of very extensive results of a component search, PARTsolutions now offers the possibility to filter different components by the respective type or category. Due to

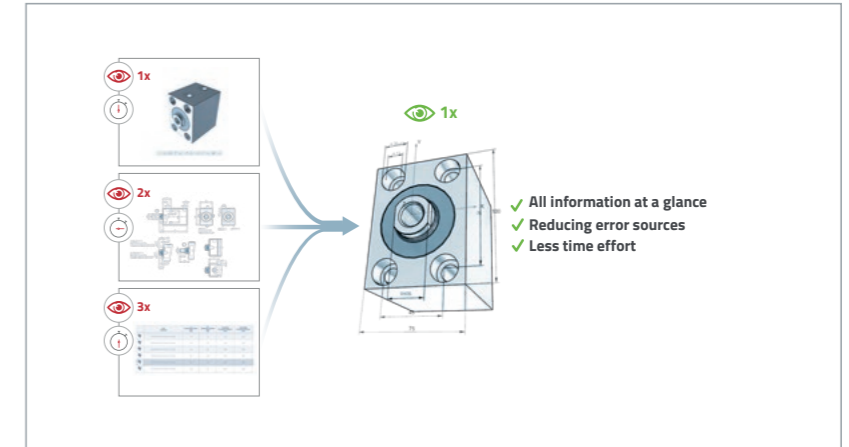

All in One View

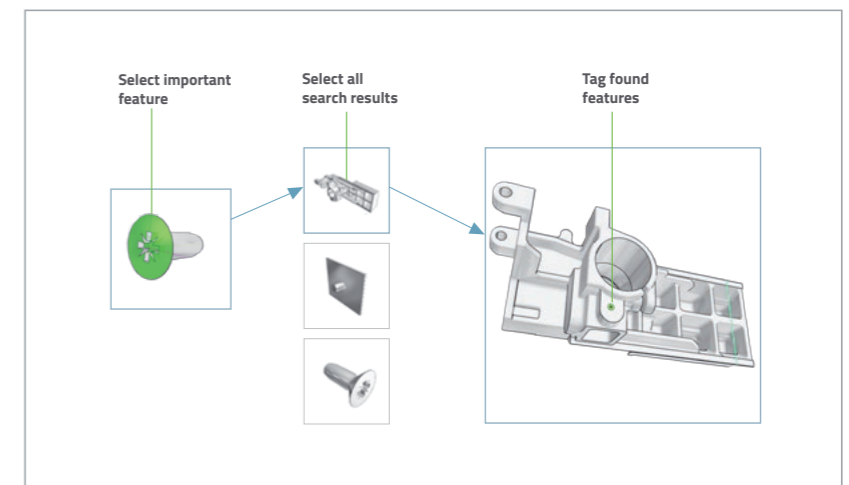

Partial 3D similarity search

the clearly arranged visualization of the search results, engineers get a good overview and can narrow the results even simpler to the relevant components.

New interfaces to CAD-, PLM- and ERP systems simplify the work

The PARTsolutions version 10 also scores with many new interfaces to acquainted CAD-, PLM- and ERP systems and seamless integrations. i.e. catalog parts can be taken over with their parts master data into the ERP quickly and easily. This way purchasers can create files of parts

master data even easier which also helps to avoid errors occurring by typing the data manually.

Further highlights of the PARTsolutions version 10 are:

- A function wizard allows the search for components without knowing the exact designation. By means of the respective component function, for instance "press" and "lock", the search for the suitable opponent can be started easily and quickly.
- Recognizing topological elements on the basis of the Capvidia functionality was further improved.
- Improved search result lists now also offer a filter possibility. Thus filtering according to fixed values and areas is possible.
- The comparison of components by means of the sectioning function was enhanced.
- Classification 2.0 – a new pioneering method to realize "classification without effort".

Would you like to learn more about CADENAS' innovation? Please turn to your CADENAS key account manager or consultant.



www.cadenas.de/strategic-partsmanagement

Or download our new PARTsolutions brochure here:



www.cadenas.de/brochure/partsolutions

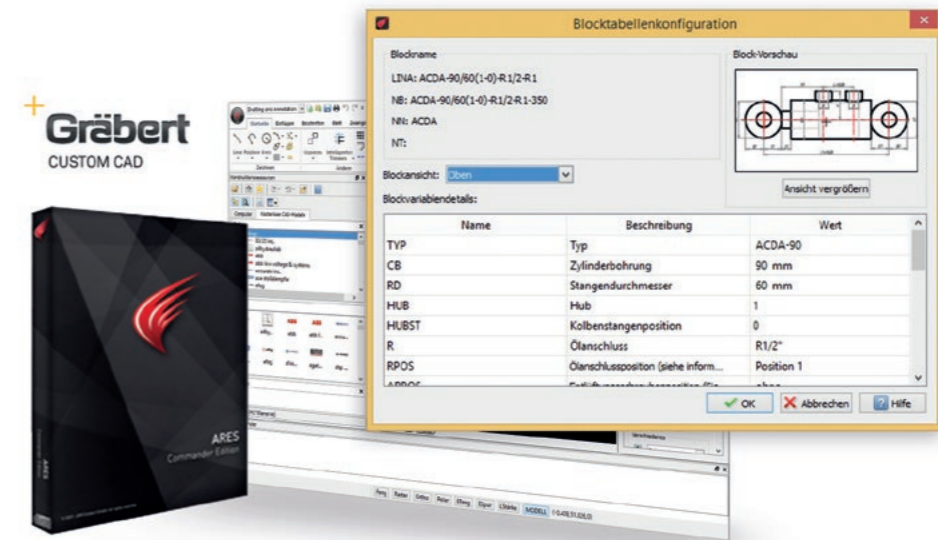
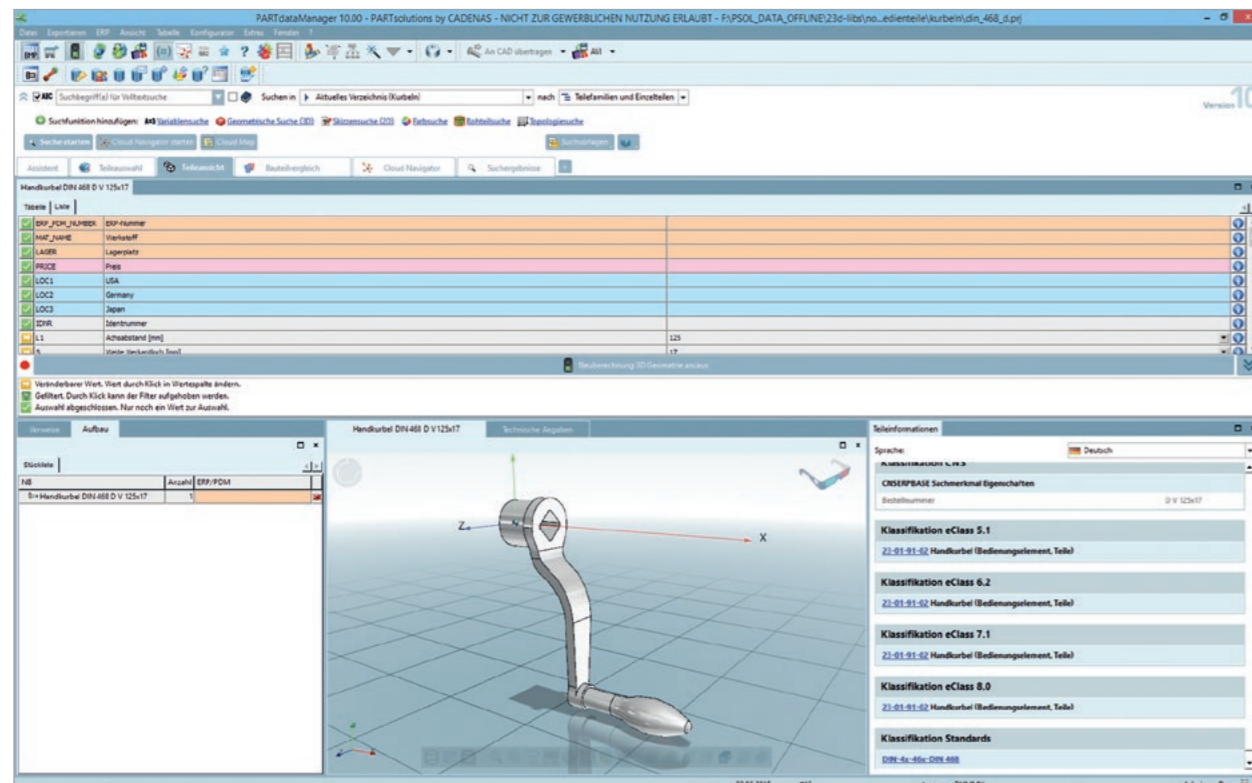

Millions of 3D and 2D CAD models are now directly available in ARES Commander, CorelCAD & DraftSight

Plugin allows quantum leap through direct access to CADENAS product catalogs

As of now, a new service is available to the fast-growing community of ARES® Commander, CorelCAD™ and DraftSight™ users: For the first time, designers can directly access millions of free CAD models from hundreds of renowned manufacturers. The desired CAD models can be directly inserted into ARES Commander, either in 3D or in different 2D views. They can be further modified in ARES Commander and used for design work. The plugin is directly integrated as a side. It is not required to register to access the libraries.

With a toolbar, the users can search the various catalogs of renowned, international manufacturers in a fast and simple way for the suitable component. Moreover, a full-text search is also available.

Premium contents are also available at very reasonable costs when users prefer to use standardized CAD models to avoid any reference to a specific manufacturer. This may for example be required when the drawing is used for a call for tenders.

The plugin was developed in a collaboration between Graebert and CADENAS. The previously tedious search for the desired standard or supplier part has been significantly simplified, thus making the design work of engineers more efficient.



PARTsolutions App

Strategic Parts Management goes mobile

As of now PARTsolutions is available on smartphone and tablet



Since the beginning of April 2015, a mobile app version of the Strategic Parts Management PARTsolutions by CADENAS is available to users.

With this new app, it is possible to visualize the PARTsolutions system environment on a smartphone or tablet. Thus, it is the first and only app that makes self-designed, standard and supplier parts combined with ERP and CAD data available for mobile devices.

Find components in an easy way

The Strategic Parts Management PARTsolutions has been efficiently supporting engineers and purchasers for a long time in finding standard,

supplier and self-designed parts in the company in an intelligent way. This reduces parts, avoids duplicate copies and thus saves costs. To have PARTsolutions at hand also in meetings, CADENAS new app offers a great amount of new features: With the PARTsolutions app the planning phase for products also gets easier. Already during project-planning meetings, engineers can look for suitable parts on the tablet or smartphone. Finding components becomes very fast and simple as the app has extensive intelligent search methods, like the Geometric Similarity



Search GEOsearch or the search with a 2D sketch. Components can be found and compared with each other very quickly and easily with CAD geometry. For this, respective self-designed, standard and supplier parts are shown in a 3D preview.

Moreover, users can also call up ERP information such as price, availability, etc. from systems like SAP. The mobile access of the PARTsolutions app to data of the company's own parts management is enabled by using the PARTapplication server for apps.

The new PARTsolutions app is available for the operating systems Android™ and iOS™ and can be downloaded from the Apple App Store and the Google Play Store:



<https://play.google.com/store/apps/details?id=de.cadenas.partsolutions>



<https://itunes.apple.com/us/app/partsolutions/id929971034?mt=8>

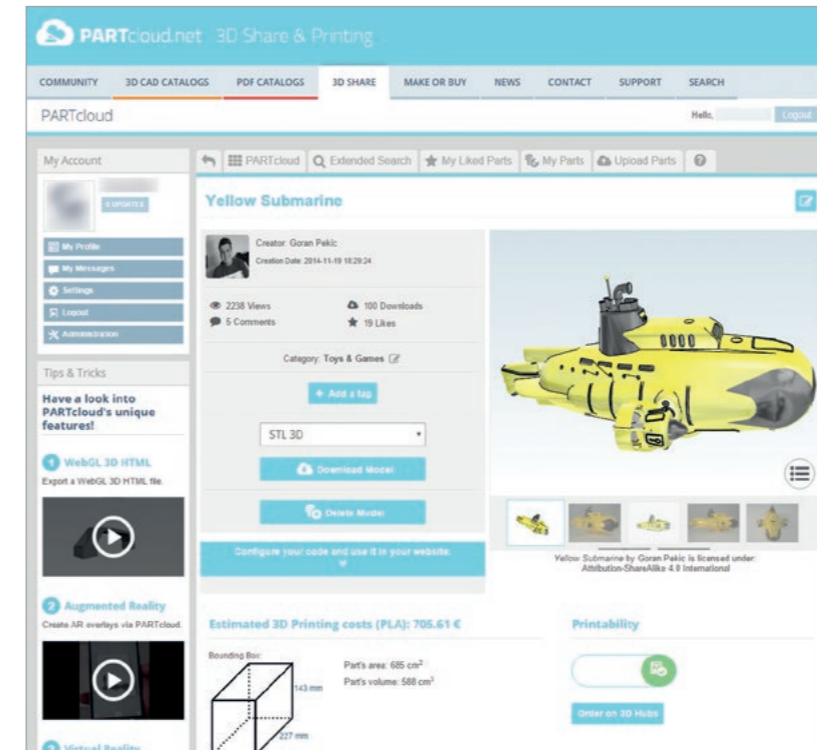
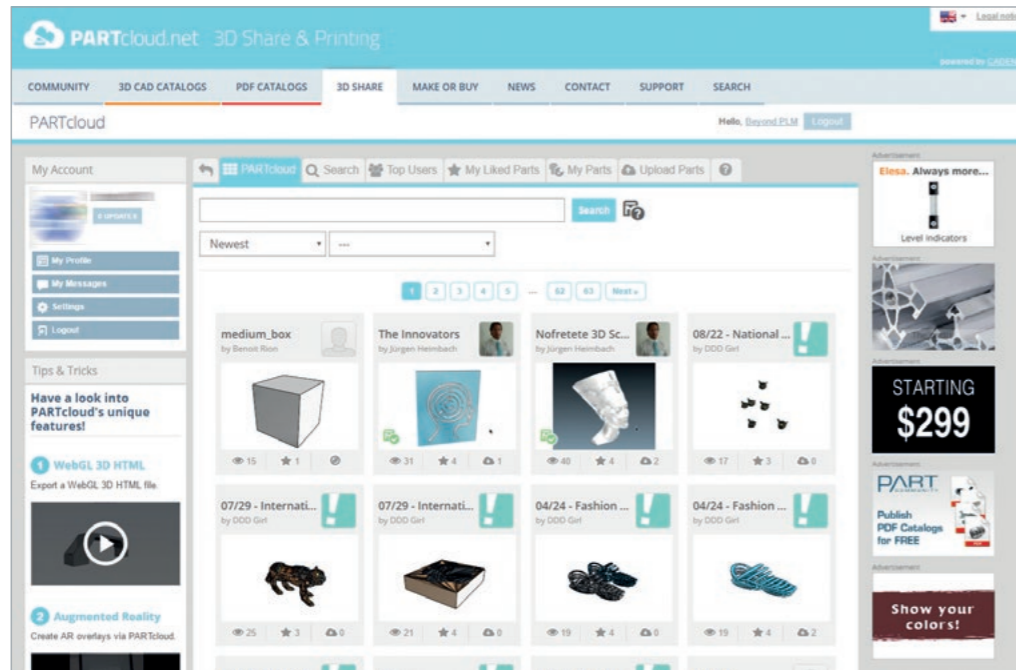

Share designs with friends and colleagues and profit from the experience of other engineers

Since the middle of 2014 engineers can simply upload their self-designed components with the PARTcloud feature of the 3D CAD download portal PARTcommunity and share them with friends and colleagues or provide them for download. Moreover users of www.partcloud.net can convert self-designed 3D CAD models of a STEP or STL format into a WebGL 3D HTML graphic in just three easy steps and afterwards integrate it into their website.

New PARTcloud version online: Now you can share parts with friends and colleagues even easier

Easier and faster handling

The 3D printing & 3D model sharing platform PARTcloud.net of the CADENAS' PARTcommunity, which is very popular among engineers, is now available in a new version. It offers new features to the users and easier as well as faster handling:

- The category under which the respective CAD model should be published can simply be selected during upload. When the next component is uploaded, this category is automatically selected.
- Due to a new WebGL viewer, the previews of the components can be loaded much faster.
- A leaner design simplifies the handling of the PARTcloud features.
- A new colorpicker with several new colors is available and the models can be easily adjusted to the Corporate Design of your own website.
- Due to the embedded service of 3DHub, the nearest 3D print service providers are displayed to the user and the uploaded CAD model can be printed in a simple and fast way.

PARTcloud.net in practice

CADENAS introduces two examples for the successful use of the PARTcloud function: The British company Poolpod Products Ltd. from Glasgow presents the 3D CAD models of their product Poolpod® by means of 3D HTML graphics, created with PARTcloud. Poolpod® is a submersible hydraulic lift for swimming pools. It allows persons with reduced mobility independent access to the swimming pool.



The function of PARTcloud as well as the previously uploaded CAD models can be found at:
www.partcloud.net

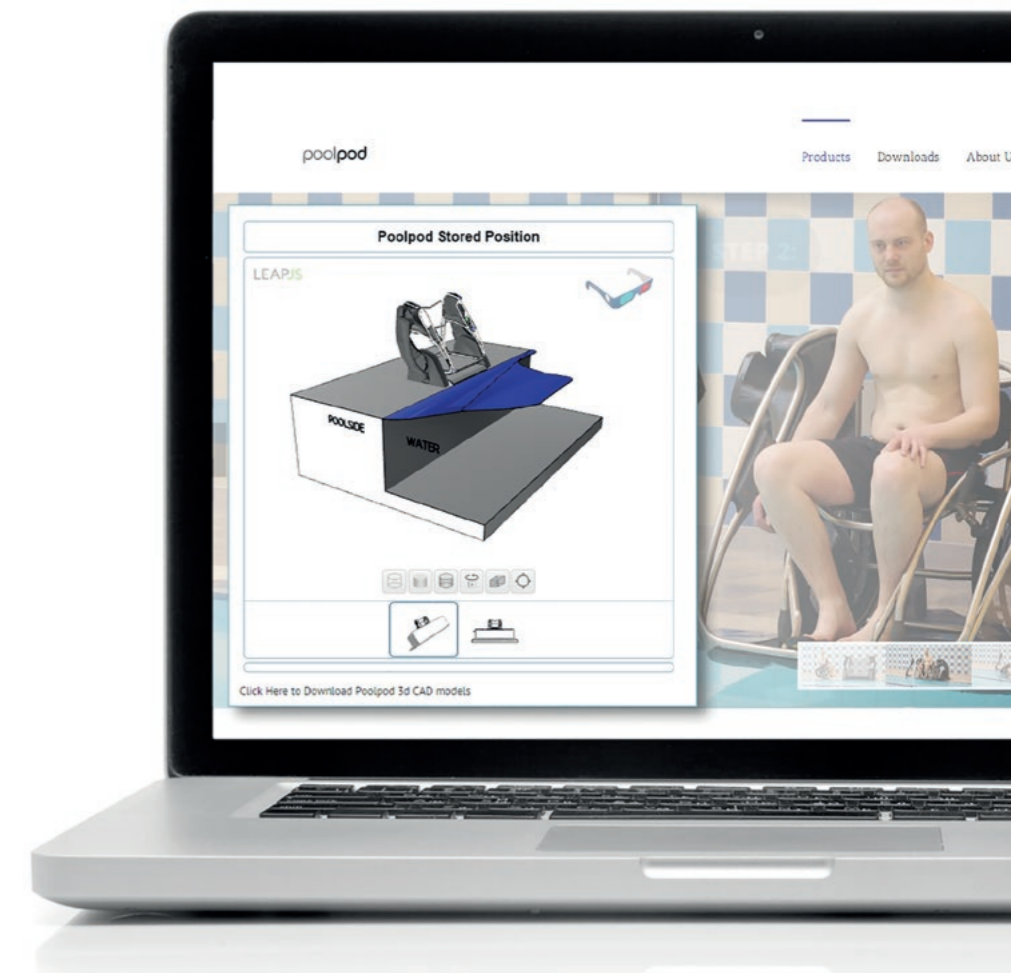



How engineers can use social media for their work

Exchange solution approaches easily and quickly

Since the middle of the 1990s, we have experienced an ongoing boom of social media, where increasingly more people exchange with other users around the globe, by using

digital media and technologies. In doing so, social networks like Twitter, Facebook, Google+ & Co., are especially popular. The social media are not only used in private areas.

Increasingly more companies and their employees believe this form of communication offers great opportunities to exchange ideas, instance with other representatives

38 % of German companies use social media activities

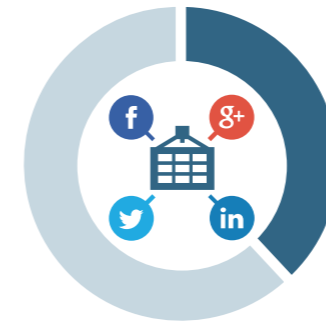

Social Media in German companies (Source: Survey from the Bundesverband Digitale Wirtschaft (BVDW) e.V.: Social Media in Unternehmen, 9.9.2014)

53 % expect an increase of the budget for social media activities



of their professional group, their customers and business partners.

Increasingly more engineers as well use the manifold possibilities of social media and networks to address their day-to-day challenges. They allow them to exchange with other engineers, colleagues or like-minded people about designs and possible solution approaches in a simple and fast way, make their engineering knowledge available to others, easily and quickly get 3D CAD models and develop or get inspirations for product ideas and improvements.

The 3D CAD download portal PARTcommunity of CADENAS, the software manufacturer from Augsburg, provides a social media platform for a thematic exchange of engineering experience.

At www.partcommunity.com there are a multitude of tools and features

offered to engineers and inventors, to find important information on engineering, like 3D CAD models or PDF catalogs and get in contact with other engineers. Moreover, the engineering platform offers numerous possibilities for bi-directional communication between the engineers and the respective component manufacturers.

Share your own 3D CAD models with other users and spread them around

An important function of social media platforms is to share knowledge or ideas with other users. With regard to the engineering sector, especially the 3D CAD models for design are of importance. Engineers can share their own designs with other users in a simple and uncomplicated way. When uploading their 3D CAD models in STEP or STL format to www.PARTcloud.net, everyone can

Network statistics from www.partcommunity.com	
	187 886 Users
	2760 3D user models
	8937 Pins
	1 310 176 Views of pins
	2255 PDF catalogs
	1 505 673 Views of PDF catalogs
	1584 News
	4765 Pictures
	504 378 App downloads

decide for himself whether only a few contacts or all users should have access to the component. Afterwards, the respective components can be set in scene and experienced in reality with anaglyph 3D glasses, Google Cardboard or a holographic display. Due to an embedded link, users have the possibility to integrate their own 3D CAD models from PARTcloud.net into their own website in a fast and easy way.

Moreover, users get an overview list for every uploaded component, with possible local service providers for 3D print. Here it is also possible to select the desired material. Especially for individual, plastic parts or soon also metal parts (additive manufacturing), this makes the manufacturing process a lot easier. This service makes a decisive contribution to efficient spare parts management in companies by minimizing storage and transport costs.

Exchange engineering knowledge and product ideas and learn from the experience of others

PARTcommunity.com as a social network is a comprehensive knowledge portal for the field of engineering, where users can interactively participate with their expertise. This helps engineers to make decades of knowledge available. With so-called use cases, users can share their experience about components or machines with end users, customers or prospective customers. Images of designs and further information as

well as a direct link to the 3D CAD model of the component are a valuable source of information for engineers. Moreover, engineers can post technical images on the internet with so called pins or get information on the topics of engineering and technology from the pin boards of other members, similar to the well-known social platform Pinterest. With a large number of different groups, it is also possible to intensively exchange ideas with other users on specific topics or problems of the daily working routine. The focus of the forums is on mechanical, plant and electrical engineering etc. This

way engineers can conveniently discuss new product ideas or improvements, giving component manufacturers important feedback about product enhancement.

Compete with other engineers at Engineering Challenges

Engineers can demonstrate their large wealth of ideas at Engineering Challenges. The competitions are initiated by component manufacturers and lure engineers with attractive prizes for the best and most creative designs. Both experienced engineers as well as junior engineers can compete here. In line with the motto "the wisdom of crowds", a tender for an engineering challenge can bring new and fresh ideas from companies for especially tricky engineering challenges. This way solutions are found quickly and in a simple way.

Direct link between engineer and component manufacturer

Social media is increasingly used in professional life, especially to directly look for information and research. Besides millions of 3D CAD models of renowned component manufacturers, PARTcommunity also provides numerous PDF manufacturer catalogs, which are a categorized encyclopedia to the majority of engineers. Within the network, users can request the respective 3D CAD model directly from the manufacturer or have alternative manufacturers for the same product shown to them. This makes the search for the desired part many times faster.

Social media will soon be an indispensable part of engineering

Often the idea of "social media in engineering" only causes a tired smile of experienced engineers and technicians and is discarded as a temporary trend. Fact is, junior engineers at universities have already internalized a working practice which intensively involves social networks and media. An important thought is that the wheel does not have to be reinvented each time, instead, ideas

can be transferred quickly and easily from other working fields to one's own application field by means of the new technology. This allows a faster approach to advanced solutions. This working method will increasingly gain ground in engineering and will sustainably change the working culture in industrial companies. In line with the motto "Life punishes those who delay", companies will sooner or later be confronted with tremendous competitive disadvantages if they do not adapt to this development.



You can find the PARTcloud feature and the CAD models that have been uploaded so far, at:
www.PARTcloud.net

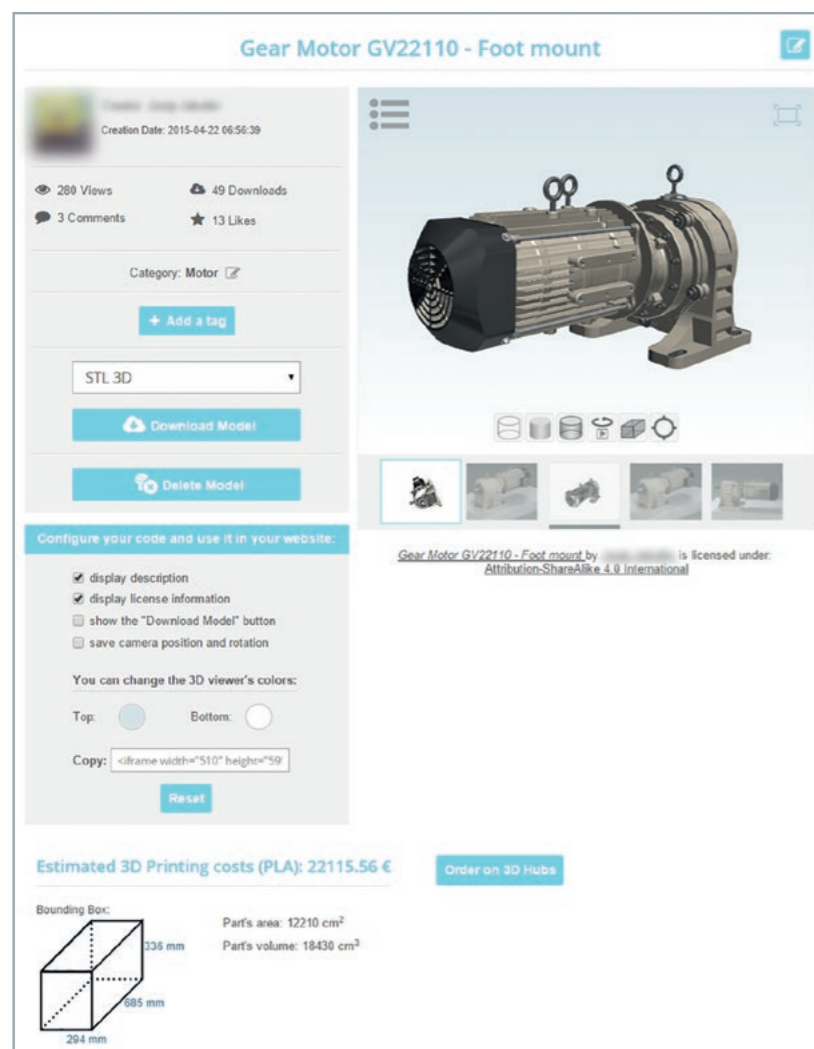

Share 3D CAD models with other users in a simple and uncomplicated way on PARTcloud.net



Learn from the experience of other engineers and technicians.

PARTsolutions allows OECHSLER time and cost savings for preparing offers

Supplier from Central Franconia implements CADENAS' 3D similarity search to optimize the management of offers

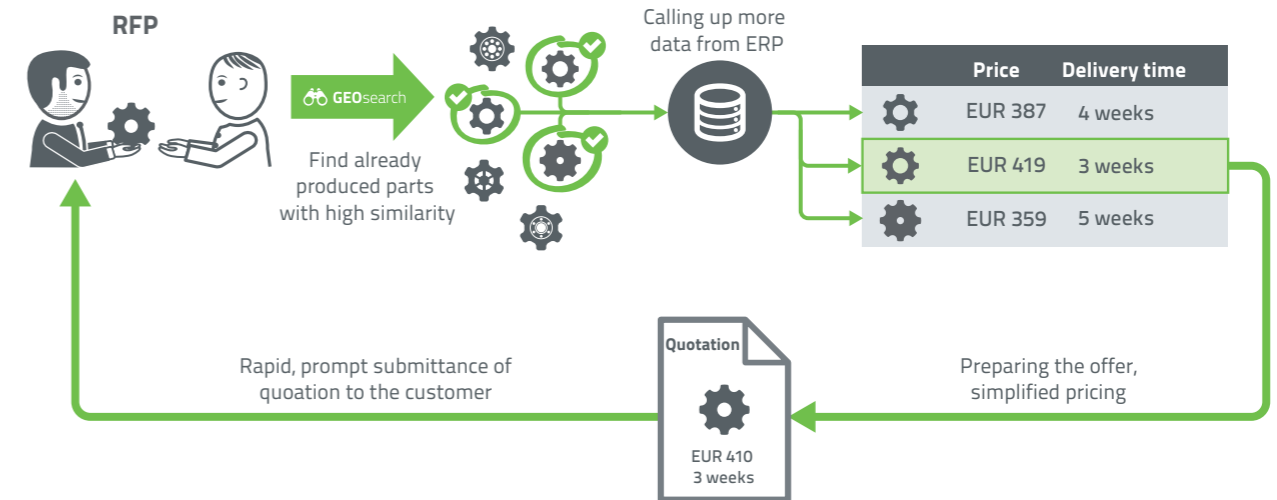

at OECHSLER, a variety of similar products for offer preparation can be filtered out due to the provided 3D CAD data. For this, the continuous collection of all CAD geometries from requested and current serial parts in production is necessary, as well as drawings of tool concepts, parts calculation and preparing offers. This results, little by little, in an extensive knowledge database. The SAP document management system, serves as database for CAD data and offer documents. After collecting the data in SAP, the 3D data is automatically indexed and a digital fingerprint is automatically created in the database of CADENAS. This fingerprint contains all characteristic geometric data of the product in processed, comparable and thus searchable form. With indexing, other meta data is exported from SAP at the same time and transferred to a PARTsolutions catalog. Then this data is available to the offer management for searches.

Now all employees know similar products

With the hit list in PARTsolutions, the person responsible can now collect data for a new offer much more efficiently and target-oriented. For this purpose PARTsolutions generates a clearly arranged catalog of similar products with a preview image. By means of the search results, the responsible person can now also access many other data from the SAP document management system, which show for instance production, processing and packing data and allow conclusions to be drawn for familiar processing problems.

With the new approach, scrap can already be specified in the offer. The access to process parameters of production and the classification of tools and injection moulding machines make the information options complete.

Even offers that do not lead to a customer order contain a lot of know-how

Offers created in this new way are afterwards fed into the SAP document management system together with the CAD data of the customer request. Thus we come about a full circle and also this new offer is then available for new requests as a source of knowledge.

"The complex analysis and research effort can be reduced by 50% this way. Offers are prepared more quickly and risky products are recognized and rated already during the offer preparation, due to a significantly more solid database", says Markus Deuter, project manager at OECHSLER AG.

OECHSLER AG is an independent, innovative and fast-growing company of the plastics processing industry. The company has its head offices in Ansbach and is currently represented at six locations worldwide. To further improve the offer

process, OECHSLER will implement CADENAS' 3D similarity search of the Strategic Parts Management PARTsolutions in 2016. This tool allows them to quickly identify similar products from the extensive database.

Powerful and target-oriented offer process

Many products, such as plastic gearwheels, screws and barrels, are geometrically similar. If a customer, for instance, requests a new gearwheel



PARTsolutions for CATIA V6 EXPERIENCE

Geberit Group introduces CADENAS PARTsolutions in 2016

The Geberit Group, with its headquarters in Rapperswil-Jona, Switzerland, is the European market leader in the field of sanitary engineering, sanitary and piping systems and bathroom ceramics. Recently the Swiss company decided to introduce the Strategic Parts Management PARTsolutions by CADENAS the software manufacturer from Augsburg.

Everything at a glance with PARTsolutions

The Strategic Parts Management PARTsolutions has numerous interfaces to CAD-, PLM- and ERP systems. Thus all technical information of a component is available at a glance without changing the system: For the Geberit Group, the CAD and PLM systems CATIA V6 Experience and ENOVIA should also be used in the course of this year. Due to the option of connecting the systems with each other, PARTsolutions will be the universal research system for Geberit's engineers and



purchasers in the future, regarding standard supplier and self-designed parts. The integrated manufacturer catalogs in PARTsolutions with intelligent parts offer a very good basis for CATIA V6 Experience.

Increasing reuse of parts

Another important reason for the Swiss company to choose PARTsolutions is their aim to increase re-use of parts. A consistent reuse of parts reduces product and development costs significantly. For this purpose CADENAS' PARTsolutions, combined with CATIA V6 Experience and ENOVIA, offers an ideal approach to support engineers

and purchasers in the future. The first 50 workstations will be equipped with the Strategic Parts Management in the second quarter of 2016. Until the beginning of 2018 all 200 work stations will be equipped with PARTsolutions. Thomas Lang, sales manager South, is optimistically about the upcoming project start: "The workshops should take place this year, so that the second project phase out of four can start in the first quarter of 2016."

"Until then we were not using a uniform solution for standard parts. In the course of introducing 3D Experience, we want to offer users additional added value from the very beginning", explains Juerg Huber, Head of Research & Development Applications of Geberit AG.

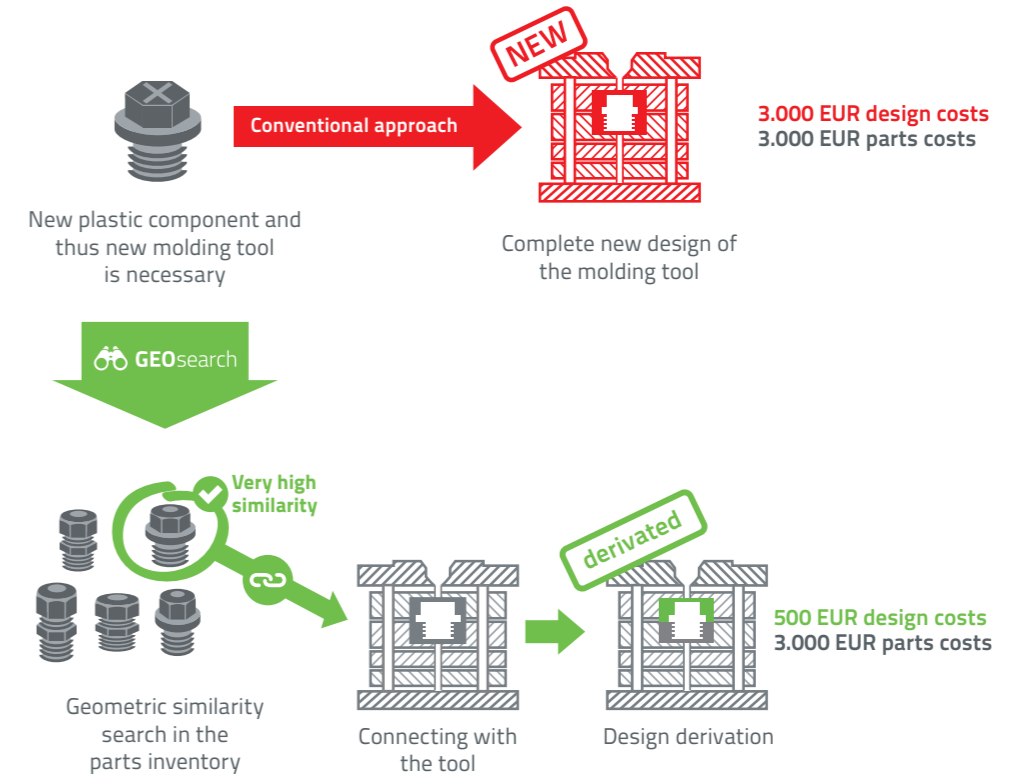

5 steps to a simple, fast and secure tool calculation

The software TOOL4SEARCH with CADENAS' integrated Geometric Similarity Search GEOsearch makes proposal preparation easier

In the calculation department for molding, die casting and pressing tools, a significant change has taken place in the last years. The amount of proposal preparations and tool manufacturing has tripled or even quadrupled. In the future, a calculator will probably have to process 1000 and more proposals at the same time, with the same reliability and quality. With TOOL4SEARCH, in connection with the Geometric Similarity Search GEOsearch of CADENAS Strategic Parts Management PARTsolutions,

it is possible to create tool calculations quickly, easily and securely. Moreover the knowledge database – with interfaces to the PPS- and ERP systems – allows efficient and time-saving and thus cost-effective working with complete order processing. To prepare a new proposal, geometrically similar plastic parts are searched for at first. From this, the existing mold making tool can be derived. By a slight modification of the tool already existing, the suitable proposal for the new mold making tool can be calculated quickly.

A powerful combination for proposal preparation

With TOOL4SEARCH in connection with CADENAS' GEOsearch, it is possible to process 1000 proposals and more in less time, with the same reliability and quality while keeping the database up-to-date at the same time.

www.cadenas.de/news/en/reader/items/id-5-steps-to-a-simple-fast-and-secure-tool-calculation





PARTcommunity version 5.0

provides a number of innovations
for users and manufacturers

Comparison of component parameters, 3D dimensioning and HTML integration of CAD models

The new version of the 3D CAD model download portal PARTcommunity has been online: Numerous improvements and innovations were introduced to make using the portal easier for the customer and more supportive for manufacturers to successfully marketing their components. The

most important improvements, like integration of a 3D CAD models into news, comparison of component parameters, dimensioning in 3D view and the news feature of the Smart Sales Tool will be explained on the following page. The Geometric Similarity Search GEOsearch now also considers the size of the searched

part, table headings remain on top when scrolling and the dimension drawings of the selected parts are displayed. Additionally the electronic product catalogs on PARTcommunity are now also available to 500 million people in China via the app WeChat – for even better distribution in China.

The most important improvements at a glance

Integrate 3D CAD models into news

Now manufacturers have the possibility to get a generated HTML code and implement the 3D CAD model into a news by means of IFrames. Users can display the model as well as configure and download it directly.



Compare component parameters

Several parts can be selected by the users and compared by means of the dimensions. Afterwards the result is displayed in tabular form and deviations are highlighted. This way the user can simply find an alternative component suitable for his purposes.

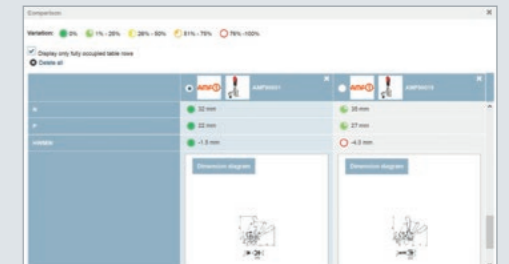

Dimensioning in 3D view

Often engineers not only need dimensioning in 2D derivations, but also for the 3D view. With the new PARTcommunity version 5.0, all component information is now displayed in a single window for the user. Thus tedious switching back and forth between the different layer windows (table, 2D and 3D dimensioning) is no longer necessary. Errors can thus be avoided and time can be saved for component research.

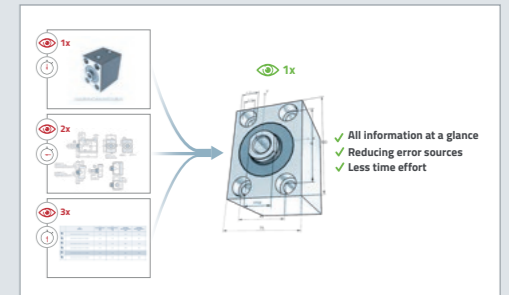

Recognize sales potential with SmartSales

For employees of component manufacturers in sales and distribution, the PARTcommunity version 5.0 offers a special highlight to recognize sales potential and improve the field sales. You can look forward to more detailed information to follow soon! If you would like to get an exclusive insight into the new features in advance, you are welcome to contact us via email Marketing@cadenas.de or via phone +49 821 2 58 58 0-0.

Top 10 Downloads

In addition, it exists the very popular feature of the "Top 10 Downloads". The table displays 3D CAD models that have recorded the most downloads in the last 30 days. The top downloads can be filtered by manufacturer catalogs and countries. Engineers can learn through the collection of the experiences of other users and see at a glance, which components are especially popular at the time and be like installed.

Innovations in brief:

- The Geometric Similarity Search GEOsearch now also considers the size of the searched part
- Table headings remain on top when scrolling and the dimension drawings of the selected parts are displayed
- The electronic product catalogs on PARTcommunity are now also available to 500 million Chinese via the app WeChat to further improve the distribution in China
- and much more

With PARTcommunity component manufacturers will be listed at the top of the Google results



Google is the most popular and most frequently used search engine in the world. On the 21st of April 2015 a new Google search algorithm was introduced, preferring all websites that are developed for mobile devices. This means that these websites are favored in the search result lists and are given a higher ranking. Websites that are not optimized for smartphones and tablets will get a lower ranking and thus might not be seen by users.



With version 5.0 of the PARTcommunity, CADENAS offers a technology that helps to optimize electronic product catalogs of the respective manufacturer in a fast and easy way for mobile devices. So far more than 70 vertical market places have already been revamped for mobile devices with the help of PARTcommunity.

Is your company website ready for smartphones & Co?

Has your website not been equipped for smartphones and tablets? Use our all-encompassing website service CANVAS, a 100% subsidiary of CADENAS. We will gladly support you with upgrading your website for mobile devices.

Here you can test if your company website is already optimized for mobile devices:



www.google.com/webmasters/tools/mobile-friendly

15.2 million downloads on PARTcommunity: We'd like to see anyone else do that

Four records in one year – CADENAS outdoes itself

Almost a doubling of download number within one year – a rising trend!

Since the beginning of the year, a rapid increase of the monthly CAD models downloads was recorded, which was not to slow down in. The number of downloads in October stood at over 15.2 million leaving the yearly total at 151.3 million downloads – tendency still rising!

Engineers and constructors can download 3D CAD components and import them in their native format to suit their CAD System needs worldwide round the clock. Currently there are over 400 manufacturer CAD product catalogs ready for download.

Moreover, the portal offers extensive search features: In every initial situation the 3D CAD model download portal PARTcommunity always finds the suitable components, regardless of whether you would like to draw a simple sketch of the product or use the geometrical similarity search GEOsearch on the basis of an existing component.

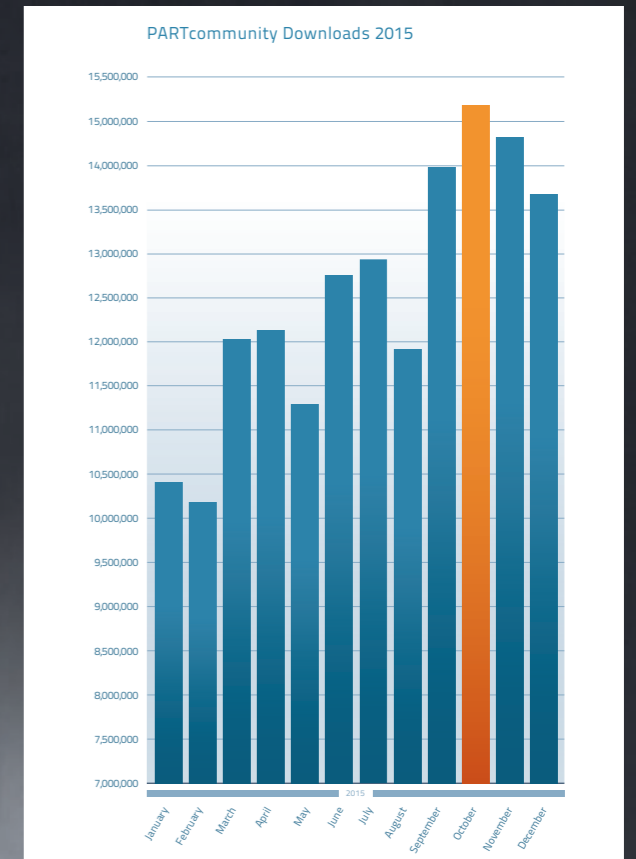

Thus PARTcommunity is one of the daily tools of millions of engineers worldwide. The electronic product catalog is ideal for marketing technical products successfully and to a broad international clientele.



Fast and efficient design with HellermannTyton

3D CAD models

Download of 3D CAD models has been seamlessly integrated into the company website

In cooperation with CADENAS, HellermannTyton is providing the 3D and 2D CAD data for thousands of its products for free to download.

HellermannTyton is one of the leading global manufacturers and suppliers of products for fastening, fixing, marking, protecting and processing cables and wires. By implementing this CADENAS service, the company has made it especially easy for engineers to find cable management solutions and then import the respective CAD models of these products directly into their design. The Electronic Product Catalog based on CADENAS' eCATALOGsolutions technology makes this possible. It currently includes HellermannTyton cable ties and fixings and cable protection products.

Seamless integration of 3D CAD download in product search results

Under the "Products" tab on the www.hellermanntyton.com website,

engineers can now view the 3D CAD models of numerous products and download them. This service is featured in the search results alongside links to supplier sources and the respective catalog page for each product. The respective 3D CAD model and its preview are shown to the user in the internet browser via

the PARTcommunity 3D web viewer. Since the middle of 2014 PARTcommunity embedded by CADENAS technology has been enabling direct integration of the 3D CAD download into the company websites of component manufacturers.

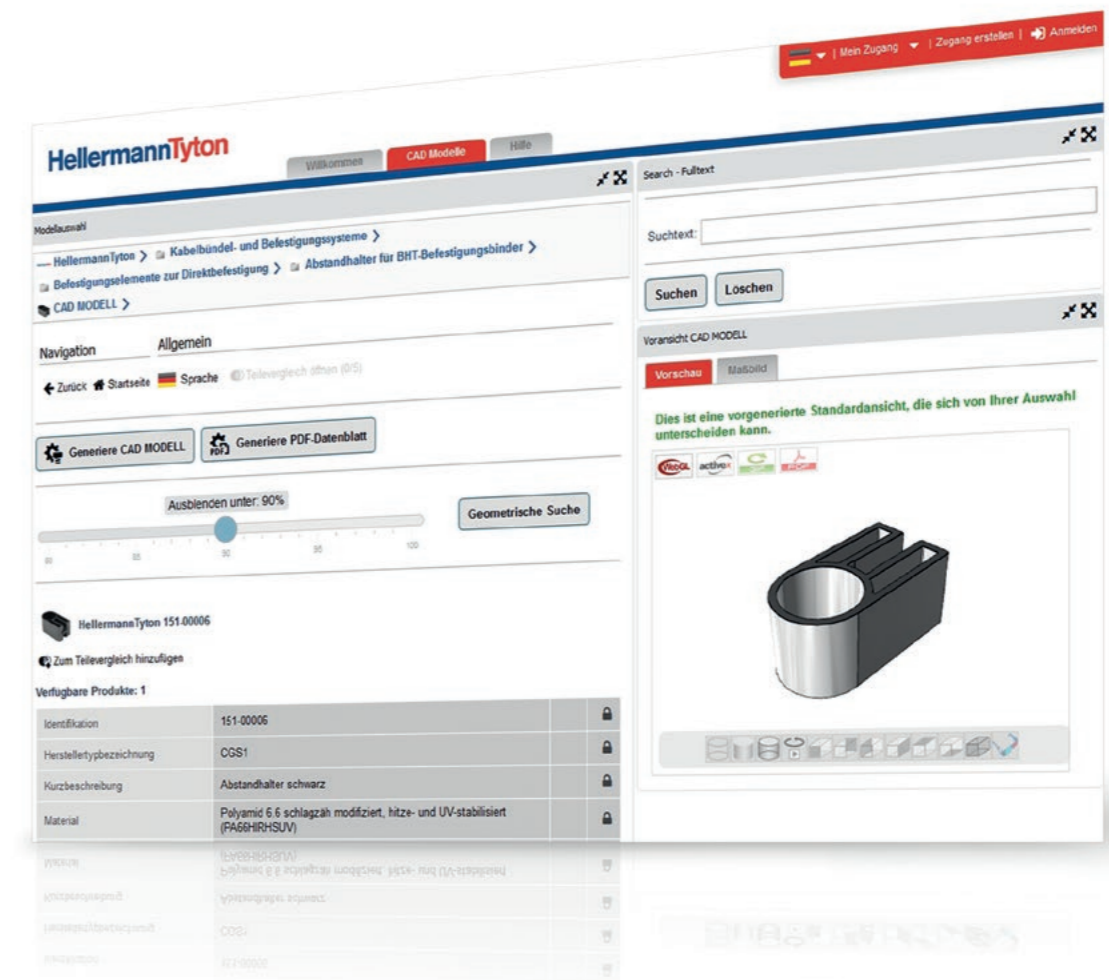
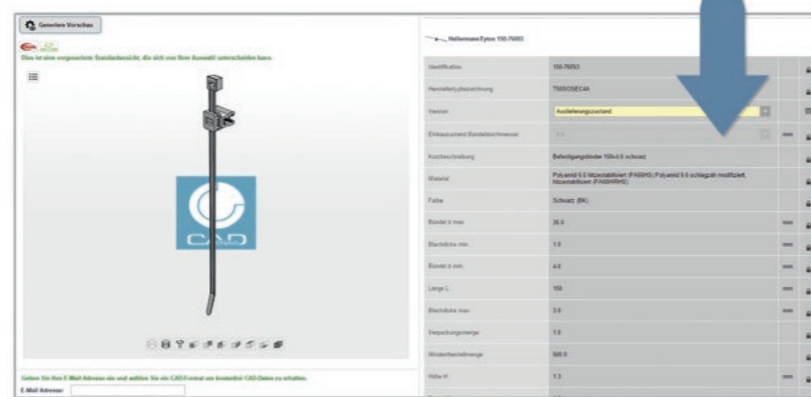

HellermannTyton's PARTcommunity download portal

HellermannTyton 3D CAD models are also available via their dedicated PARTcommunity download portal. Engineers can browse for parts in the catalog structure or discover them using the full-text search at <http://hellermanntyton.partcommunity.com>.

Afterwards, the CAD data of the desired product can be downloaded in all established formats and imported into the CAD system, or sent via

email. Moreover, a PDF data sheet providing precise product dimensions, materials, product properties and the scope of delivery is available.

"The results of our comprehensive 2D and 3D CAD service are enormous time savings and optimal support during the design phase. This in turn leads to significant cost savings for our customers and prospects", says James Hill, Communication Manager at HellermannTyton. "We are pleased with the take-up of the service and are extending the products in the database step by step".

More information can be found at www.hellermanntyton.de/site/allgemein/cad-datenexport



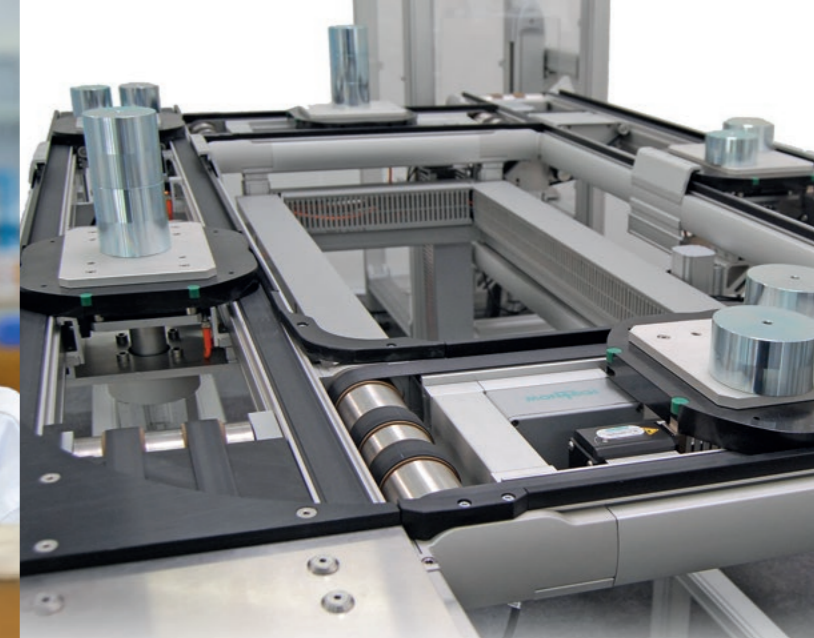





At Montech: Proposal preparation in just 30 minutes than one working day

eCATALOGsolutions as comprehensive overall solution

Interactive product configurator in figures

-  Application since 2004
-  Phasing-in period of the interactive product configurator: 8 weeks
-  30 PARTsolutions working stations
-  Saving of time for proposal preparations: Formerly 1 working day, now 1/2 hour

To offer the best customer service in international markets, Montech AG, the Swiss expert for conveyor technology, has been relying on an encompassing online service for more than 10 years. Important components are for example the online shop, product configurators and the 3D CAD download portal <http://montech.partcommunity.com>.

The Montech AG has been using CADENAS' eCATALOGsolutions technology for Electronic CAD Product Catalogs since 2002. In addition, the interactive product configurator for the transport system LT40 was implemented in 2014.

Less effort for proposal preparations

Especially layout planning, price calculation and proposal preparation was very complex for Montech AG. First the company was given a detailed sketch, afterwards a design in the CAD system was following and at last the prices had to be calculated in the ERP system and the proposal had to be prepared manually. Since the implementation of CADENAS' interactive product configurator, a very fast proposal

preparation is possible. "With the IPC the effort for proposal preparation was reduced to 1/2 hour", says Murat Simsir of Montech AG. "Especially with regard to the return on investment (ROI), this saving of time is very interesting, since the investment pays off very quickly."

Significant profit for customers as well

For users of the interactive product configurator with 3D view window, the handling is very easy. The available standard components can be automatically installed and are assorted in the IPC as a library. This allows the fast configuring of a track section including peripheral components with the respective system specifications and settings. Users get a PDF in the corporate

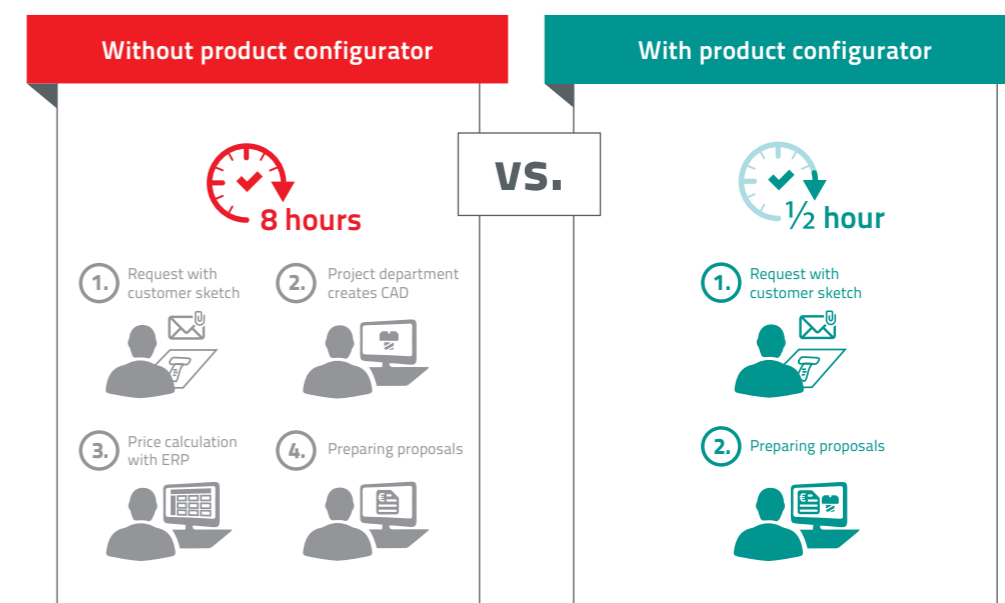

design of Montech by clicking a button, which provides them with all important technical data and a dimensioned 2D layout. With the export feature, the configured transport system LT40 or the quick set system can be exported into the most current formats such as 2D or 3D model.

Moreover, it is also possible to create an offer in a fast and easy way for the configured transport system in IPC. The interactive product configurator also had a positive effect on the Swiss company's sales. A fast proposal submitting is a decisive competitive edge for Montech.

More information, tips and tricks about the interactive product configurator you can find in common success story under:

<https://www.cadenas.de/ecatalogsolutions/customers/success-stories#MontechAG>



» The possibility to configure a system together with the customer directly on-site and submit proposals in no time, is an outstanding service. «

Murat Simsir
Montech AG



New AVENTICS CAD product catalog

In cooperation with CADENAS, AVENTICS provides 3D CAD models for download



In cooperation with CADENAS, AVENTICS introduced their new 3D CAD product catalog at the Hanover Fair 2015. Under <https://aventics.partcommunity.com> customers and prospective customers can now download 3D CAD models of the following cylinder and drive unit product groups for free: NFPA, PRA, TRB, RTC & MSC.

Great customer service is top priority

With the newly created 3D CAD product catalog, which is based on the eCATALOGsolutions technology of CADENAS, the software manufacturer from Augsburg, AVENTICS can offer an all-encompassing download service for CAD models in all current CAD

formats to engineers, designers, planners and purchasers.

AVENTICS is a globally active manufacturer of pneumatic components and systems. The company is a specialist supplier of drive and control solutions for the marine industry and pneumatic in commercial vehicles as well as tooth chains for drive and

transporting systems. The former Bosch Rexroth subsidiary has been operating independently on the market under the name AVENTICS since the beginning of 2014. The company has around 2100 employees worldwide.

Far more than 3D CAD models

Users can look for CAD models with extensive search features with the clearly arranged catalog structure at: <https://aventics.partcommunity.com>. It is possible, for instance, to find certain parts with a simple sketch or an uploaded picture by using the GEOsearch feature. Alternatively there is a full-text search, which uses auto-fill to show a selection of suitable terms already when entering them. This way engineers and purchasers quicker get to the desired product of the manufacturer, with its headquarters in Laatzen near Hanover. Afterwards the respective 3D model can be simply integrated into the existing design.

3D PDF data sheets provide all important product information

Additionally customers and prospective customers can download the 3D PDF data sheets of AVENTICS cylinder and drive unit product groups, containing all important information about the respective component and providing them in a compact and descriptive way.

Both technical data and drawings, PDF data sheets also have a 2D and 3D

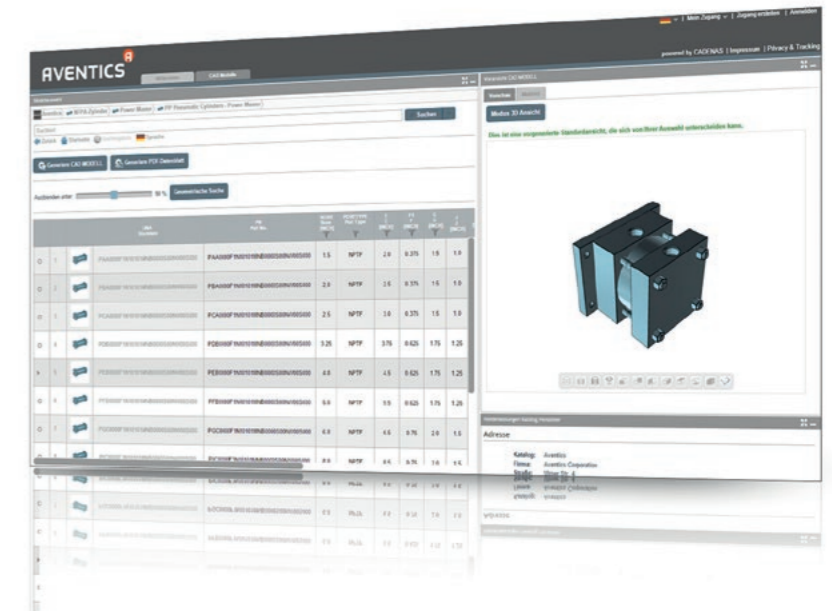

» We decided for the 3D CAD product catalog of the software manufacturer from Augsburg, since CADENAS is the market leader in this field and thus the benchmark. With our new 3D CAD product catalog we now offer our customers also 3D CAD models in many native CAD formats for download. «

Rainer Kemmler
AVENTICS GmbH

preview of the product on the first page. "We decided for a 3D CAD product catalog of the software manufacturer from Augsburg, since CADENAS is the market leader in this field and thus the benchmark. With our new 3D CAD product catalog we now offer our customers also 3D CAD models in many native CAD formats for download", says Rainer Kemmler from

AVENTICS. "With CADENAS, the AVENTICS' 3D CAD models are available on many online portals, allowing us to penetrate the market even better."



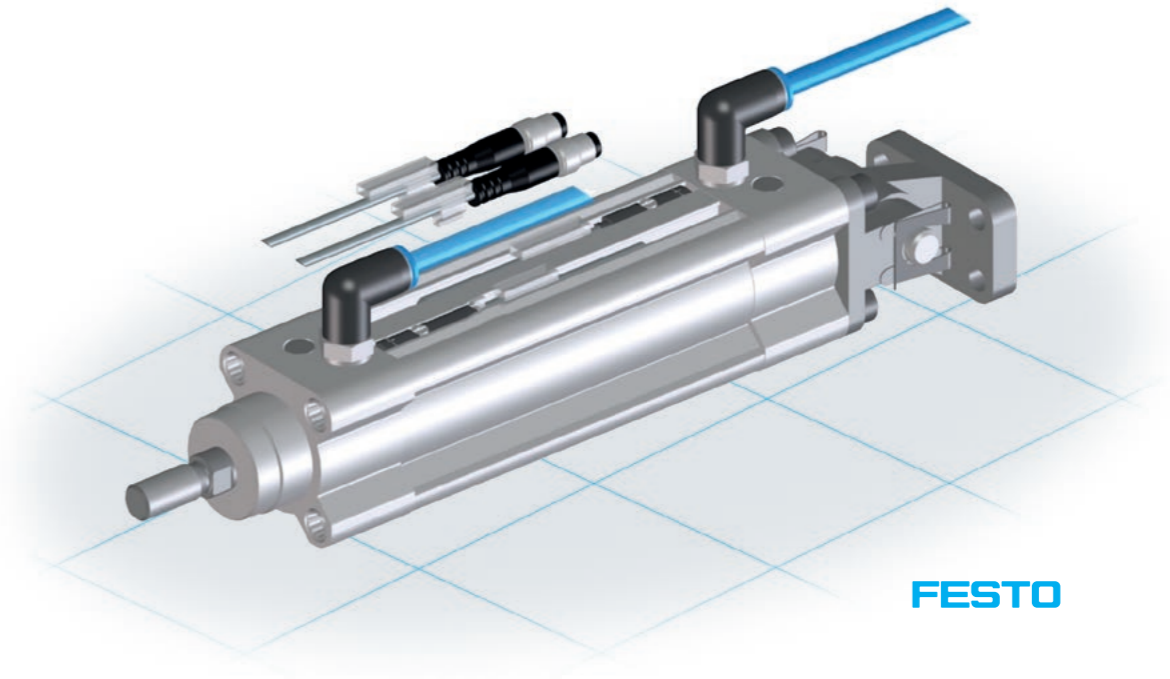
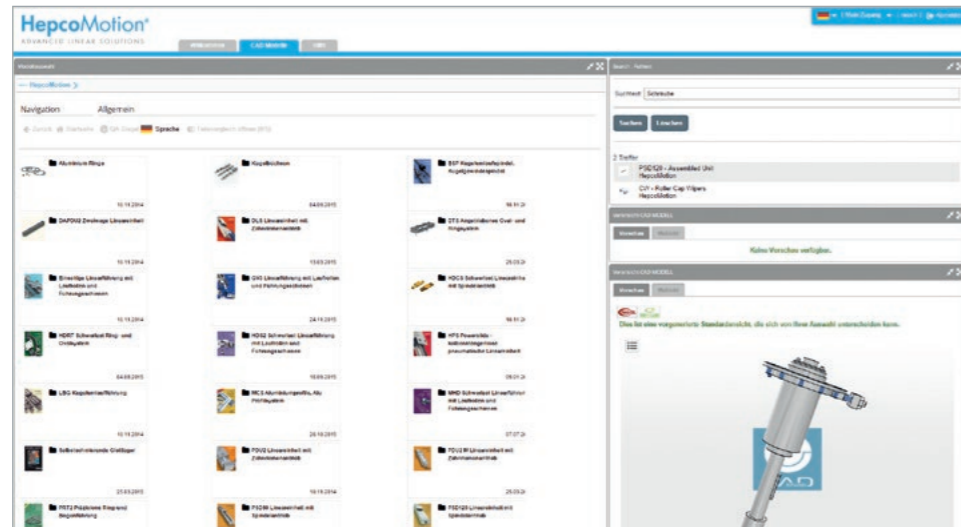

FESTO

HepcoMotion relies on PARTcommunity technology for 3D CAD download

HepcoMotion 3D CAD models available in all current CAD formats

HepcoMotion® has been a world-leading manufacturer of linear motion system for 40 years and provides 3D CAD models of its products for free download in all current CAD formats. At <http://hepcotion.partcommunity.com>, engineers, technicians and purchasers have access to CAD models of numerous HepcoMotion products and after download they can integrate them directly into their design.

Quickly get to the desired HepcoMotion component

User of HepcoMotion's 3D CAD download portals have access to a full-text search that shows a selection of suitable terms. Many part models can be configured prior to download. For example, the length of the linear

»» Specifiers of HepcoMotion® products will benefit greatly from this change as it makes importing CAD data quick, easy and reliable. CAD generated by CADENAS is one of the world's most trusted sources of this type of data and we are also committed to developing the site as part of our continuous improvement program. ««

Peter Fanshawe
Managing Director
HepcoMotion®

slide and number and position of carriages can be set rather than the customer having to edit models on his or her own system. This way engineers and purchasers get their desired product faster and easier. The respective 3D CAD model can be easily integrated into the existing designs.

You can find HepcoMotion's 3D CAD download portal at: <https://hepcotion.partcommunity.com>

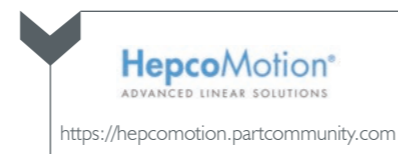

Comprehensive update for the Festo Design Tool 3D

Quickly find the pneumatic assembly group with extended software

Fast, safe and efficient – the Festo AG & Co. KG have published an update of their new configuration software Festo Design Tool 3D, which was developed in cooperation with CADENAS, the software manufacturer from Augsburg and created on the basis of the Interactive Product Configurator.

So far there has always been a residual risk when designing and ordering pneumatic drives. The designer had to place many single parts manually in the CAD system and long order parts lists were created. Thus there was a high error potential.

The Festo Design Tool 3D for pneumatic systems saves time-consuming work steps in the long

term, which leads to significant time savings for the customer as well as a considerable decrease in errors. Delivering the system assembly as a whole package, with only one ordering position, simplifies logistics and assembly.

More product systems and more accessories

With the Festo Design Tool 3D (FDT 3D), customers can generate product combinations quickly, automatically and free of errors in the CAD system and order the complete assembly group with only one position.

With the update, users get access to even more product systems and other accessories of the core product

range. Thus customers, for instance, find the rotary actuator DRRD, the mini-slide DGSL, the short stroke cylinders ADVC and AEVC as well as the guided drive DFM. The one-way flow control VFOV and the non-return valve HGL were added to the accessories.

The Festo Design Tool 3D is available under www.festo.com/FDT-3D.

If customers already own the Festo Design Tool 3D, they can download the update under the tab „Extras“ and „PARTupdate“.



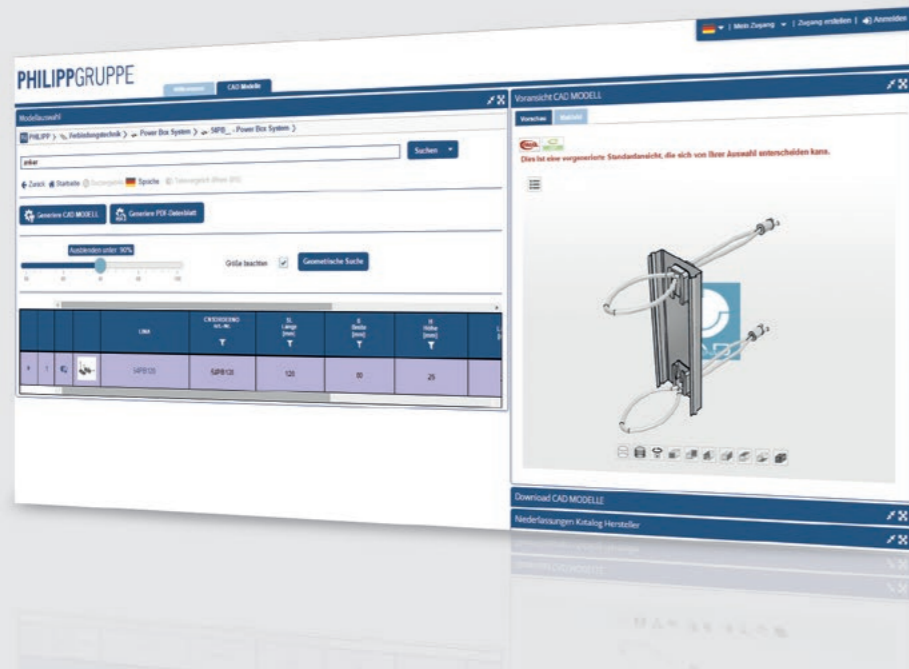

PHILIPP group supports the BIM process in structural engineering with eCATALOGsolutions

Package offer 3D built-in parts in online catalog with eCATALOGsolutions

In modern prefab construction you cannot do without mounting parts. Designers increasingly fall back on 3D design and develop a model of the prefab construction from geometry, reinforcement and embedded built-in parts. Structural engineers, however, can invest only a little time in developing these parts, which

then is missing at another stage of the project, since there is a very tight schedule. To support engineers with this issue, PHILIPP offers an extensive online catalog of their product portfolio for transport and assembly systems, based on eCATALOGsolutions technology by CADENAS. The most

important transport anchor systems, connecting and fixing rails as well as sandwich anchor systems and many more, are included in the catalog, available as detailed 3D models and 2D views. Thus, the creation and expansion of CAD internal embedded parts libraries becomes significantly easier.

Export of IFC, Autodesk Revit and many other formats are possible

In doing so, PHILIPP makes its contribution to the increasingly important process of Building Information Modeling (BIM) in structural engineering. The embedded library is convincing with scope, topicality, compatibility and information content.

The offer, free of charge for the engineer, represents an universal platform since it supports almost any CAD system because of different export formats.

The most important export is defined by the IFC format, which can be read out by many CAD programs established in the embedded parts and building sector. But also native CAD data for most CAD systems regarding building design, such as Autodesk Revit, can be exported. Both AutoCAD as well as Allplan by Nemetschek can be additionally served via special interfaces. CADENAS, a leading software manufacturer for electronic CAD products, provides a solution with interfaces that are always up-to-date.

Collision check and fast modeling

The PHILIPP online catalog is simply structured and equipped with all important facts about an embedded part, which are basically taken from the technical information. This way engineers can quickly find the right part and thus accelerate the modeling of three-dimensional elements

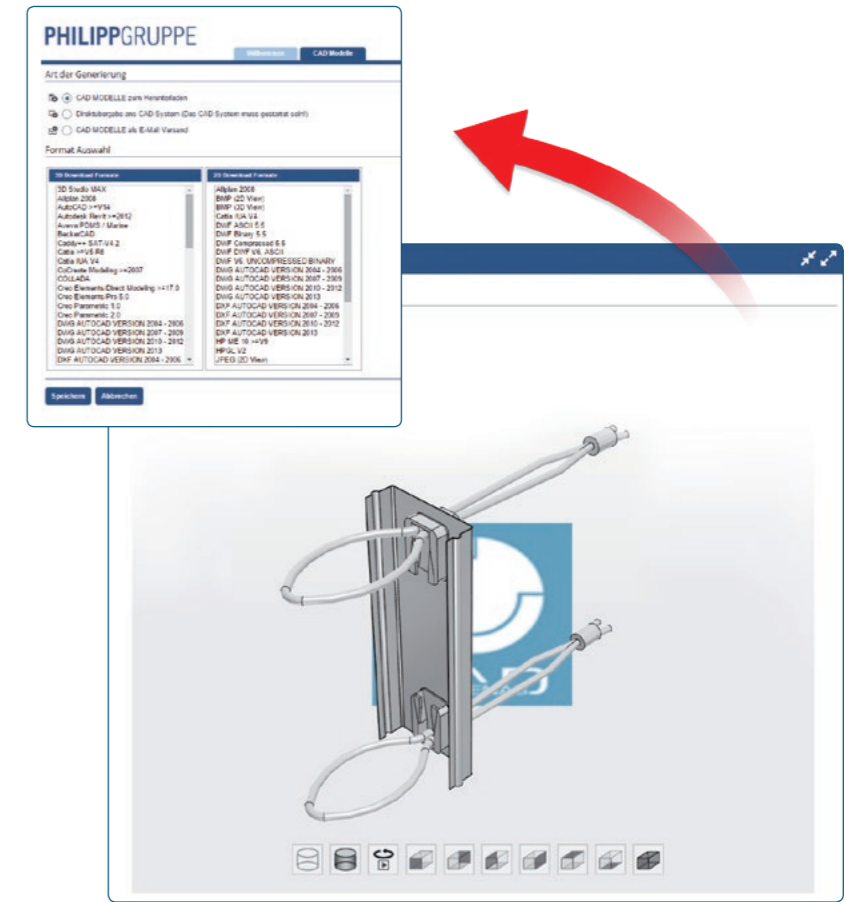

and carry out collision checks, for instance between reinforcement and an embedded part. The data models are reduced to the essentials for assembly and visualization, to avoid any unnecessary burdening of the CAD systems, but they are also sufficiently detailed to ensure precise planning.

The catalog is available on the website of PHILIPP under products/PHILIPP Software or directly at: <http://philipp.partcommunity.com>

PHILIPP catalog available at BIMcatalogs.net

Due to the new Electronic Product Catalog, based on CADENAS' eCATALOGsolutions technology, the catalog of the PHILIPP group is now

also available on BIMcatalogs.net. It is here that designers, architects, constructors, structural engineers and executing companies get free access to an extensive platform with current building design data in native CAD formats and in the IFC format. By publishing their catalog on BIMcatalogs.net, the PHILIPP group benefits from an ideal, target-group oriented and worldwide marketing of their product.

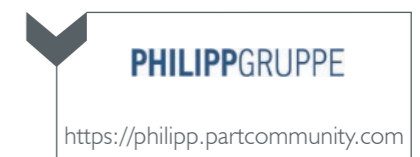





First 2D & 3D BIM CAD Product Configurator for smoke ventilation and fire safety systems

SOUCHIER relies on CADENAS' eCATALOGsolutions

An overview of the project

 First 2D / 3D BIM CAD configurator for fire safety systems

 Generates with an output format many native 3D BIM CAD formats (Nemetschek Allplan, Autodesk Revit, IFC ...)

 Convinces with an outstanding price-performance ratio

The initial situation at SOUCHIER

The expert for developing and producing naturally looking smoke and heat ventilation systems has seven employees working in the design department and facing a multitude of inquiries: For their

building design projects, customers request information on mounting spaces, technical data and how to ensure a feasible product configuration as well as 3D BIM CAD models of products.

The complexity of products

SOUCHIER products do not have predefined standard dimensions. Instead, they are individually customized. This is why the design department at SOUCHIER often receives similar customer inquiries. CADENAS' product configurator aims at providing customers with a complete product configuration, precisely down to the millimeter, including motorization and possible versions, while at the same time reducing the workload of the design department.

Time savings

Before introducing the product configurator, SOUCHIER published a few plans on their website, but they could not sufficiently meet the demands and requests of the customers.

- Which dimensions does the product have?
- What kind of configurations are possible?
- Is it possible to get drawings with the necessary dimensions?

The customer requests had to be forwarded to the design department at SOUCHIER, which then created the required CAD drawing.

»» The goal was to save time on both sides. With the configurator, the customer gets the response to his question immediately, while SOUCHIER can concentrate on the more difficult cases due to the reduced amount of inquiries. ««

David Maillart
Manager research and development
SOUCHIER

Implementing the configurator

SOUCHIER eventually chose CADENAS because of the outstanding price-performance ratio. Since the online configurator was implemented at the end of January 2014, three different products are available: Airlam V2 (ventilation screens for fresh air supply from the external facade), Exubaie and Exubaie V2 (single wing smoke and heat ventilation for the facade). Exubaie is the most important industrial application for the design department. The goal was to reduce the workload for engineers. The addition of two more product lines are already planned.

The benefits of a product configurator

The product configurator of the company SOUCHIER is the first 2D and 3D configurator for the areas of ventilation and fire protection on the market. It enables real 3D visualization of integrable ventilation products all construction or renovation projects.

"We started with the facade products, since they are easier. Most inquiries are for Exubaie, hence this product has the greatest impact on our business", David Maillart explains.



Avoiding configuration errors

A product can be easily selected from SOUCHIER's portfolio and parameters, dimensions, opening type and angles can be entered. The 2D/3D BIM CAD configurator analyzes and checks the compatibility of the selected elements and immediately shows a 3D view of the configured system. The user friendly interface and the intuitive navigation take the user step by step to the desired configuration.

Select product

Different kinds of views are available to the user, like a 2D view, a 3D view, an exploded view and many more. Moreover, it is possible to export the CAD drawings into different formats to provide the right smoke ventilation system to decision makers, design

offices, design engineers and project managers. All relevant data sheets can also be generated and downloaded as PDF data sheet.

3D plans for architects

There is an increasing demand for 3D drawings, especially among architects. In addition to the AutoCAD format, the configurator offers many other 3D formats including Nemetschek Allplan, Autodesk Revit®, IFC, Solidworks, Autodesk Inventor®, CATIA, Solid Edge, Creo, and many more.



AZOLGAS-NITROCYL

goes CADENAS: Large scale customer service

As of March 2016 customers can download products in 2D and 3D CAD formats on the basis of the eCATALOGsolutions technology

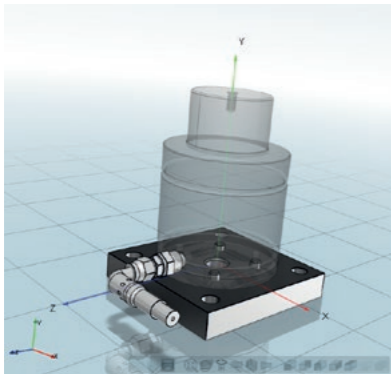

AZOLGAS-NITROCYL will soon provide 2D and 3D CAD data of its gas springs and suitable accessories for free download in cooperation with CADENAS. As of 03/01/2016 the products will be available online in all common 2D and 3D CAD formats.

Integration of 3D CAD downloads into the product search results

AZOLGAS-NITROCYL is an innovative manufacturer of gas springs and tool accessories based in northern Spain. Due to intensive research and the development of new products, the technical demands of the customers are fulfilled. This is why manufacturer will soon publish its Electronic Product Catalog based on CADENAS' eCATALOGsolutions technology, whose CAD Models can also be downloaded in the desired native CAD format.

For the Spanish manufacturer it is important to support customers already when using their products in the planning phase. With this service, the company makes it especially easy for engineers and tool makers to find gas springs and import the respective CAD models directly into their design.

On the website www.azolgas.es (and soon also on www.maerkische-stanz-partner.de) engineers can search for the 3D CAD models of numerous products, look them over, configure them and start the download. After product selection, the 2D or 3D drawing can be taken over directly into the existing design in the desired target format.

PARTcommunity downloadportal of AZOLGAS-NITROCYL

Moreover, the 3D CAD models of AZOLGAS-NITROCYL are also available on the 3D CAD download portal PARTcommunity. Under <https://azolgas.partcommunity.com> (=Azolgas) and soon also under <https://maerkische-stanz-partner-partcommunity.com> (=NitroCyl) Engineers can look for the desired component by means of the clearly arranged catalog structure or the various intelligent search features. Afterwards the data of the product

can be downloaded in all current native CAD formats into the respective CAD system or sent via email.

Calculate your potential

More than 80 vertical online market places, which are constantly extended, serve as multipliers for the electronic product catalogs. With a potential of worldwide more than 14.4 million engineers, the 3D CAD models in the electronic product catalogs of component manufacturers reach exactly the right target group.

Calculate your marketing potential now: www.cadenas.de/calculator

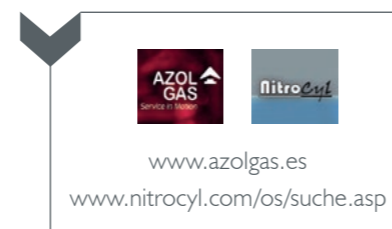

Generating sales with an interactive 3D news

Why manufacturers already set a good example at the downloadportal PARTcommunity

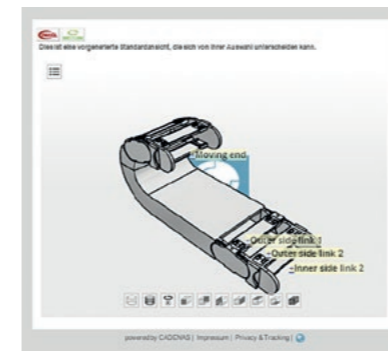



With the new 5.0 version of the 3D CAD model download portal PARTcommunity, which has been online since November, manufacturers have a new and innovative highlight at their disposal: The integration of a CAD model into the news. We would like to explain to you with 3 arguments why this is an important innovation and what the benefits are.

Use news as sales area

Only with the 3D CAD model download portal PARTcommunity component manufacturers have the possibility to implant a CAD model as an IFrame in the news and use it as an additional sales platform. This way a user can read about a new CAD component, look at it the same time, configure it, download it into the CAD system and convince himself about it. And the best is: Creating an IFrame doesn't cost you a thing and every user can create and insert an HTML element himself!

3 arguments for an IFrame and the better commercialization of your products

- 

The customer may inspect immediately the described part from the news, configure and download to the respective CAD system.
- 

The 3D view provides a better screening of the part and facilitates the assessment of the customer.
- 

A CAD component that is downloaded via PARTcommunity, is also sold in 87% of cases.

This is how simple it is:

Just select the suitable component in the "3D CAD catalog" tab and click the options as in the example under "additional information". Then click the button "copy to clipboard" and insert the section of the corresponding news post in the source code. Done!

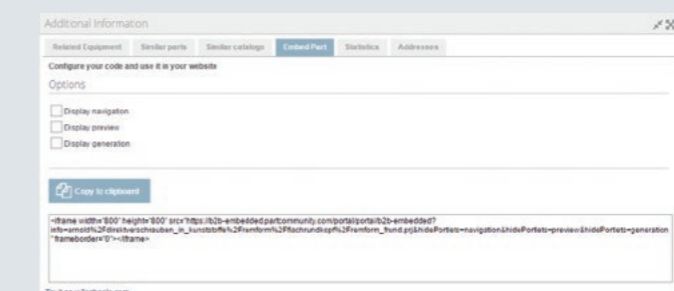

With the feature "Try it on w3schools.com" you can also look at your 3D CAD model in a preview before you integrate it into the news.

PARTcommunity now available in WeChat – additional marketing in China

For a successful presence in Asia WeChat is a must

As of now the 3D CAD model download portal PARTcommunity can also be found in the social app WeChat. Because whoever wants to market products successfully in China cannot do without WeChat. It is a very extensive platform combining features similar to Facebook, WhatsApp, Amazon etc. Already 500 million are using the app, outside of China alone 100 million. This means about every third Chinese is already using WeChat. Since the complete mobile life in China takes place in WeChat, the app offers companies a multitude of possibilities to present themselves and interact with many customers in the best possible way. Also storing predefined message is possible, so the user gets an answer when he contacts the company via messenger. At WeChat, service is of special importance and not the sole advertisement for the company.

PARTcommunity is using WeChat as marketing tool

The 3D CAD download portal PARTcommunity has so far been very popular in Asia, which is shown by the current download figures: The platform had 28.1 million downloads from China, Japan and South Korea in the past year alone. With WeChat, CADENAS is further expanding its market position in Asia.

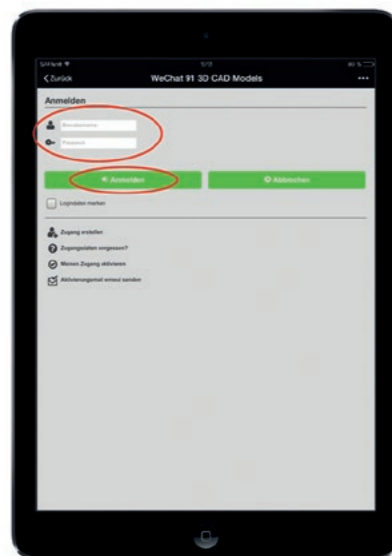

Only a touch of the finger away from PARTcommunity with WeChat

PARTcommunity has its own WeChat channel, providing users information about the 3D CAD download portal. In addition, you can read messages and communicate with PARTcommunity directly.

With the app you can look at the 400 manufacturer-certified catalogs with 3D CAD models, configure and download parts. A simplified login makes handling of the app easier.

Discover new chances – we will help you!

We recommend CADENAS' eCATALOGsolutions technology and the 3D CAD download portal PARTcommunity to you, if you would also like to present your products in China.

Calculate your potential

More than 80 vertical online market places, which are currently being extended, serve as multipliers for CADENAS' electronic product catalogs. With a worldwide potential of more than 14.4 million engineers, component manufacturers internationally reach exactly the right target group with the 3D CAD models of their electronic product catalog.

Calculate your marketing potential now: www.cadenas.de/calculator



Main functions of WeChat: Social Media, Messenger, Pictures, Payment, Music & Sounds, Calls, Discount, E-Shop.

For these systems available: Windows, Apple iOS, Android, Blackberry.

Popularity of WeChat: 500 Mio users per month, 1 out of 3 uses WeChat in China, 100 Mio users overseas.

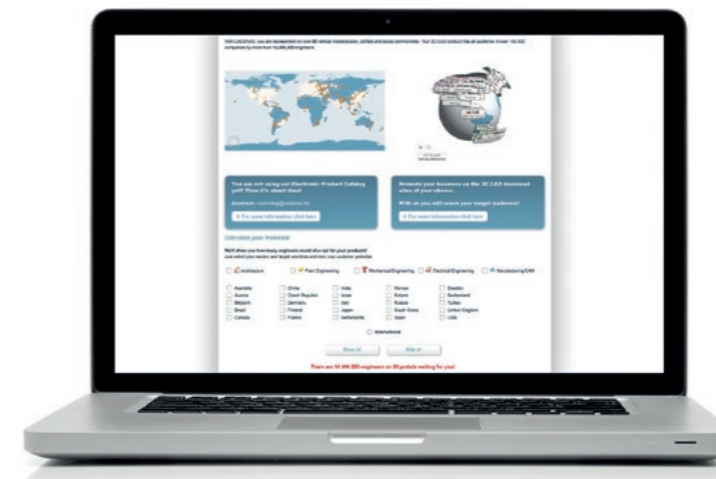

CADENAS – The Innovation Company

The 3D CAD download portal PARTcommunity, a pioneer in the sector, as first and only provider of 3D CAD catalogs, started a WeChat channel, including the download possibility of more than 85 different CAD formats. Thus manufacturers

of components, who are already providing their catalog data with the eCATALOGsolutions technology on PARTcommunity, have an extended access to the Chinese market and benefit from wide-ranged and international marketing.

Useful information:

Would you like to set up a WeChat channel yourself?

In Europe, a registration with an existing Facebook account is even possible. We will gladly support you with setting up the channel.

Do you have any questions?

Contact us with subject "WeChat" under Marketing@cadenas.de or call us under: +49 821 – 2 58 58 0-0.



www.partcommunity.com

CADENAS Wall calendar 2016

With CADENAS' PARTsolutions you reduce parts diversity, decrease costs and reach a higher level of standardization for the parts you are using. This way you profit from the highest saving potential in your company. A study of Ehrlenspiel confirmed, that the more successful a company is, the fewer diverse parts it has. PARTsolutions help to reduce costs sustainably and effectively, accelerate process and reduce parts diversity. Also intelligent search features are available.



A large hidden potential is waiting for you! Go for it now and reduce duplicate copies. By means of PARTsolutions with its numerous features, you make the daily working routine of your employees easier and do not only save time, but also costs.

Download at:
www.cadenas.de/kalender/partsolutions-2016



Hologram DREAMOC HD3

Give yourself the illusion!

With a holographic display of DREAMOC technology you create the perfect illusion.

With floating 3D animations, you will have incredible opportunities to present for example at trade fairs.

The eCATALOGsolutions Calendar 2016 is rewritable with a whiteboard marker...

...and thus very flexible – just as the innovative marketing strategies by CANVAS. The communication agency is especially there for eCATALOGsolutions customers and leads to targeted campaigns.

Download at:
www.cadenas.de/kalender/ecatalogsolutions-2016



There is no CADENAS Calendar 2016 hanging on your wall yet? Just write an email with the subject »eCATALOGsolutions Kalender 2016« or »PARTsolutions Kalender 2016« to Marketing@cadenas.de. We will be pleased to send you your personal copy, while stocks last.

Imprint

Editor:
CADENAS GmbH
Berliner Allee 28 b + c
D-86153 Augsburg
Germany

Phone: +49 821 2 58 58 0-0
Fax: +49 821 2 58 58 0-999
Info@cadenas.de
www.cadenas.de/en

Editorial office:
Annika Litzel, Lieve Nantke,
Stephanie Benirschke

Graphics, layout:
Kerstin Reiß, Carolin Risinger

© 2016 All rights reserved.
Reproduction or electronic distribution
only with previous consent of the editor.

CADENAS Setting Standards

CADENAS is a leading software developer in the areas of Strategic Parts Management and parts reduction (PARTsolutions), as well as electronic product catalogs (eCATALOGsolutions). With its customized software solutions, the company acts as a link between the component manufacturers with their products and the purchasers.

With its 300 employees at 17 international subsidiaries, the name CADENAS (Hispanic: process chains) has been standing for success, creativity, support and process optimization since 1992.

In its role as initiator and pioneer, CADENAS has already established many important innovations and trends.

PARTsolutions innovations:

- PURCHINEERING 2.0: Optimized cooperation between purchase and engineering, including automatic background service to avoid creating new part unnecessarily
- Find components in an intelligent way: Geometric Similarity Search, 2D Sketch Search, Topology Search, Cloud Navigator Suche, Unmachined Part Search, Color Search, Partial Search and many more
- Classification 2.0: Parametric reference model instead of manual classification

eCATALOGsolutions innovations:

- Intelligent 3D CAD models – far more than geometry: Ideal product and engineering data with maximum comfort & functionality
- PARTcommunity Embedded – seamless integration of the 3D CAD model download portal into company websites
- Smart Sales – know who and where your customers are: Offer products at the right time, the right place, to the right person
- 3D CAD model app – mobile access to millions of standard & supplier parts
- BIMcatalogs.net: Worldwide marketing of your components to architects, civil engineers and planners
- Supporting the Augmented Reality technology

Further information at: www.cadenas.de/en

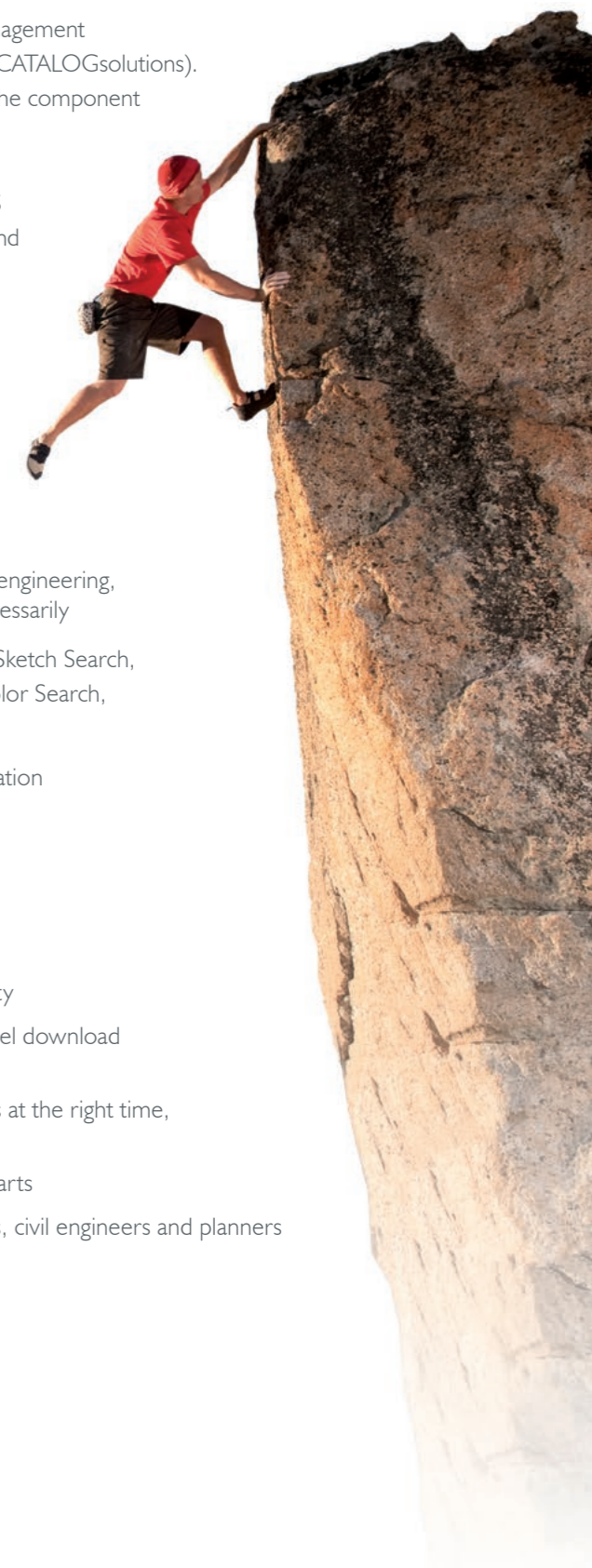

CADENAS unites manufacturers & suppliers of components with the industry!



CADENAS solutions for
manufacturers & suppliers of components

The Electronic Product Catalog



The software solution to create and promote Electronic CAD Product Catalogs.

The Intelligent CAD Models



More than geometry: Optimal product and engineering data with the maximum comfort and functionality.

The Smart Sales Solution



Know who and where your customers are: Offer products at the right time, right place and to the right people.

The Vertical Marketplaces



Numerous online marketplaces with millions of users to multiply your Electronic CAD Product Catalog.

The Trade Show Entertainment Package

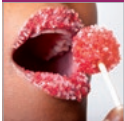

Market your technical products in a sexy and innovative way.



CADENAS solutions for
industrial buyers of components

The Strategic Parts Management

Sustainable cost reduction of standard, supplier and company parts for engineers and purchasers.



The Geometric Similarity Search

Find available CAD geometries in a smart way and classify them semi-automatically.



The Supplier Portal

The platform improves the communication to external suppliers.



The PURCHINEERING Concept

Improves the cooperation between purchasing and engineering.



CADENAS GmbH Augsburg

Berliner Allee 28 b+c
D-86153 Augsburg
Phone: + 49 821 2 58 58 0-0
Fax: + 49 821 2 58 58 0-999
E-Mail: Info@cadenas.de
www.cadenas.de/en

The CADENAS Group worldwide:

Austria Phone: +43 664 24 52 713
Italy Phone: +39 051 04 16 776
France Phone: +33 4 74 55 26 96

Spain Phone: +34 932 74 95 40
USA Phone: +1 (513) 453-04 53
UK Phone: +44 7949 69 67 51
Croatia Phone: +385 35 63 82 25

South Korea Phone: + 82 505 936-93 60
Turkey Phone: +90 216 695 24 01
Japan Phone: +81-3-59 61-50 31
China Phone: +86 21 63 55 13 18

Copyright 1992-2016 CADENAS GmbH. All rights reserved. CADENAS, PARTsolutions, eCATALOGsolutions, PARTcommunity, PURCHINEERING, PARTcloud, ePRODUCT-placement, PARTserver, smartPART, web2cad und BIMcatalogs are brands of CADENAS GmbH, Augsburg. All further brand names, company names or product names are brands or registered trademarks of their rightful owner. Not liable for any information.